

## IPPD-5500-9131

The IPPD-5500-9131 has a rugged appearance and a waterproof structure that provides IP65 waterproof and dustproof protection. The ultra-high brightness of 2500nits means that the video can be seen more clearly. The 16:9 size fits all types of applications. High-quality LCDs provide high-resolution, high-contrast images for the deepest blacks. Convenient functions such as remote control, automatic environmental dimming and IR control are built in.

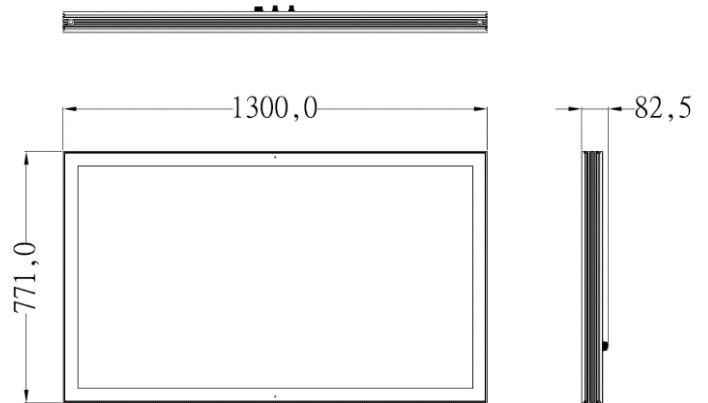

### LCD Specifications

Model	IPPD-5500-9131
Panel	55 inch
Back Light Type	LED (white LED)
Resolution	Full HD 1920 x 1080
Pixel Pitch	0.63( H ) x 0.63( V )mm
Display Colors	16.7M Color (RGB 24bit)
Active Screen Size	54.6"
Display Area	1209.6 x 680.4 mm
Aspect Ratio	16:9
Brightness (Full White)	2500 nits (Typical)
Contrast Ratio (Full On/Off)	3200:1 (Typical)
Viewing Angle (CR>10)	178 degrees (Horizontal and Vertical)
Response Time	9 ms (Typical)
I/O Interface	RJ45 x 1 HDMI x 1 Power Input x 1
Power Control	AC ON/OFF switch / Sleep Mode
Remote Control	RJ45 (TCP/IP)
AC Power Input Range	100~240VAC, 50/60Hz
Power Consumption	189 W (Typical)

### Litemax Electronics, Inc.

Headquarters  
8F, 137, Lane 235, Bau-Chiau  
Rd. Shin-Dian Dist., New Taipei  
City, 23145, Taiwan

Tel: +886-2-8919-1858 Fax: +886-2-8919-1300  
<http://www.litemax.com>

US Office  
48531 Warm Springs Blvd. #414,  
Fremont, CA 94539  
Tel: 1-510-509-7506

<b>Dimension (W x H x D)</b>	1300 x 771 x 82.5 mm
<b>Weight</b>	54 Kg
<b>IP level</b>	IP65
<b>Operating Temperature</b>	0°C to 50°C
<b>Storage Temperature</b>	-20°C to +60°C
<b>Humidity</b>	10% - 90%, non-condensing
<b>Backlight MTBF</b>	100,000 hours (Typical)
<b>Chassis</b>	Aluminum alloy
<b>Certification</b>	CE/FCC/BSMI

※ All specifications are subject to change without prior notice.

---

**Litemax Electronics, Inc.**

Headquarters  
8F, 137, Lane 235, Bau-Chiau  
Rd. Shin-Dian Dist., New Taipei  
City, 23145, Taiwan

Tel: +886-2-8919-1858 Fax: +886-2-8919-1300  
<http://www.litemax.com>

US Office  
48531 Warm Springs Blvd. #414,  
Fremont, CA 94539  
Tel: 1-510-509-7506

Note :  
A : 16-M8\_USER\_HOLE\_MAX\_DEPTH=8mm

Chassis Material : Aluminum  
Chassis Color : Pantone 432C

Front Screen Material : AG Glass  
Front Bezel Color : Black

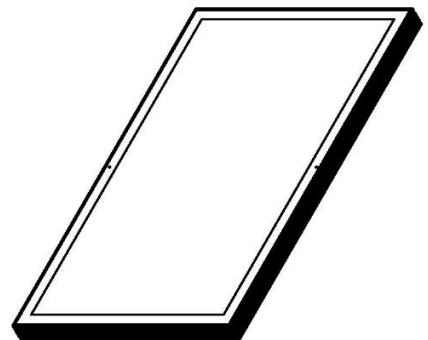
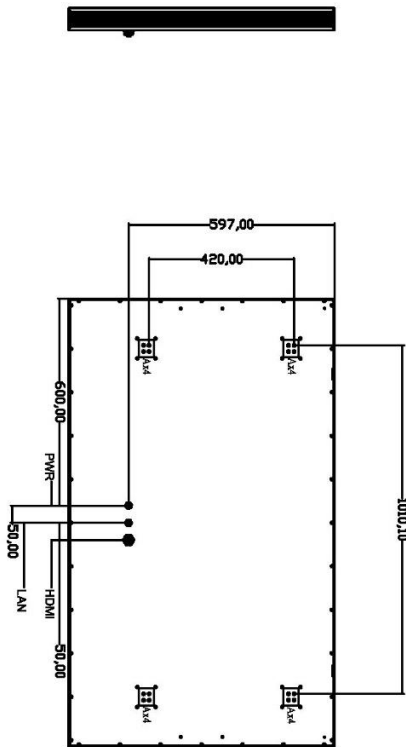
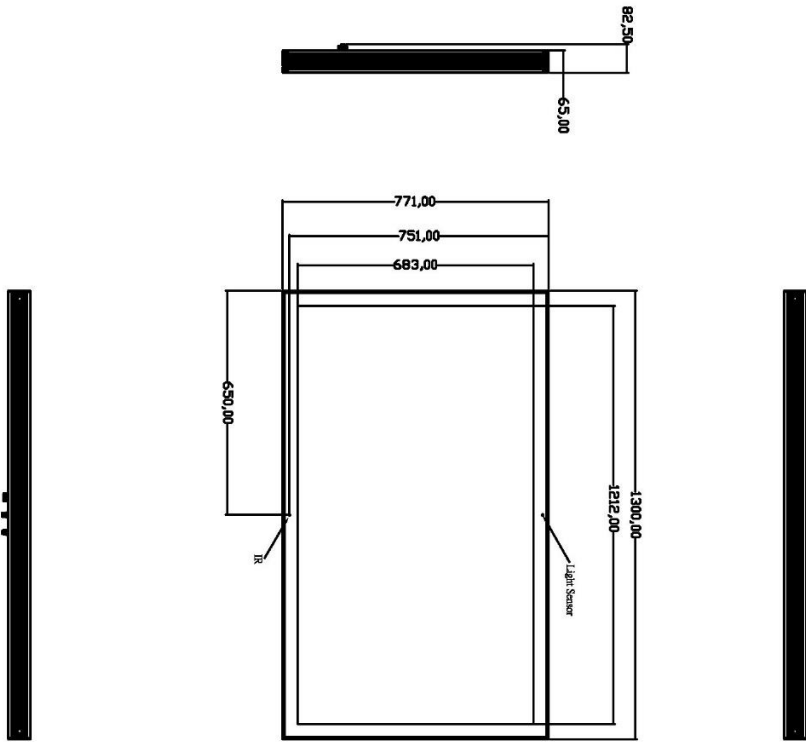

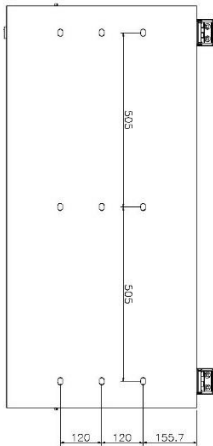
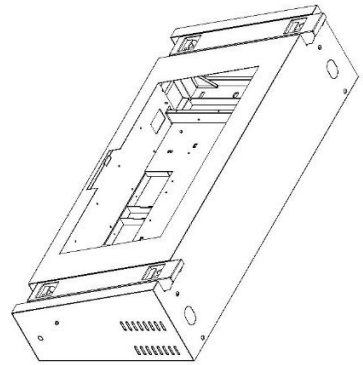
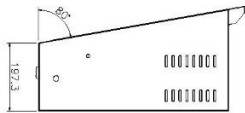
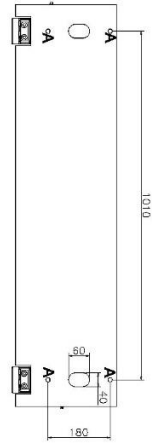
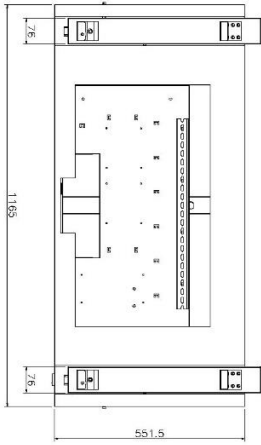
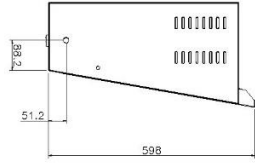

Note :  
 A: 4-M12\_USER\_HOLE\_MAX\_DEPTH=30mm  
 Chassis Color : Pantone 432C  
 Material: SECC (Main 3t ; Cover:1.0t)  
 Weight : 37KG ± 5% (not including equipment)  
 \*Size and weight vary by configuration  
 and manufacturing process.

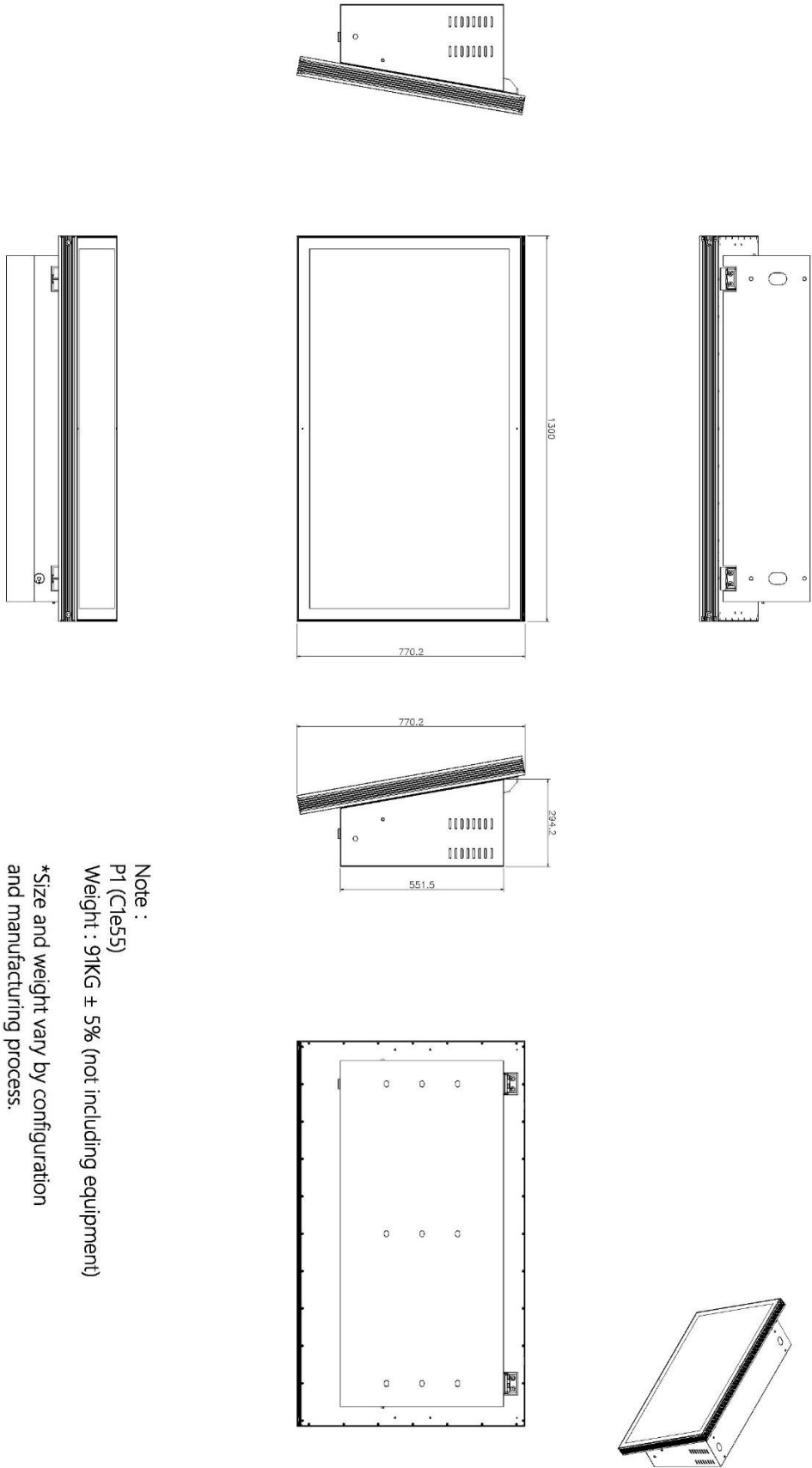

Note :  
P1 (C1e55)  
Weight : 91KG ± 5% (not including equipment)  
\*Size and weight vary by configuration  
and manufacturing process.