



# EC500-SD

Q170



## ► Features

- Supports DDR4 SODIMM up to 32GB
- Three independent displays: 1 VGA + 1 DVI/HDMI + 1 HDMI/DP
- Compact and cost-effective solution
- Rich I/O connectivity: 2 GbE, 4 COM, 4 USB 3.0, 2 USB 2.0
- 2 Mini PCIe slots support mSATA and Wi-Fi modules



## ► Panel

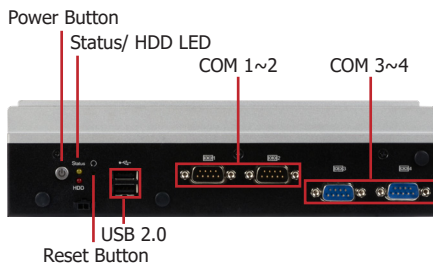

Front View

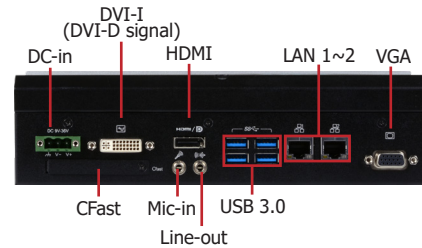

Rear View

## ► Dimensions

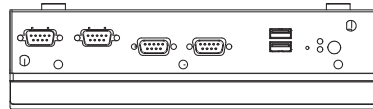

Front View

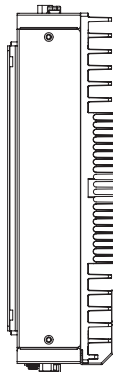

Left View

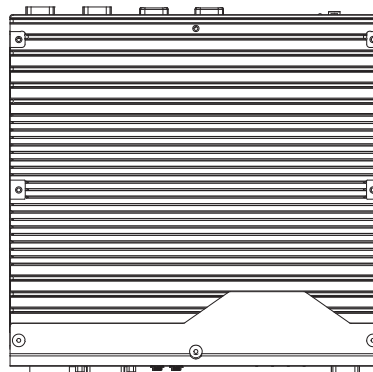

Rear View

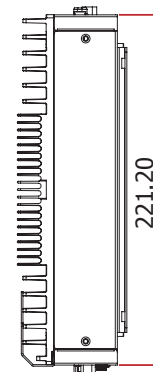

Right View

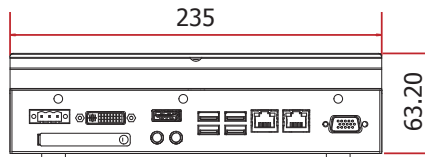

## ► Specifications

<b>SYSTEM</b>	<b>Processor</b>	6th/7th Generation Intel® Core™ Processors, LGA 1151 Socket Intel® Core™ i7-6700TE, Quad Core, 8M Cache, 2.4GHz (3.4GHz), 35W Intel® Core™ i5-6500TE, Quad Core, 6M Cache, 2.3GHz (3.3GHz), 35W Intel® Core™ i3-6100TE, Dual Core, 4M Cache, 2.7GHz, 35W Intel® Core™ i7-7700T, Quad Core, 8M Cache, 2.9GHz (3.8GHz), 35W Intel® Core™ i5-7500T, Quad Core, 6M Cache, 2.7GHz (3.5GHz), 35W Intel® Core™ i3-7101TE, Dual Core, 3M Cache, 3.4GHz, 35W
	<b>Chipset</b>	Intel® Q170 Chipset
	<b>Memory</b>	Two 260-pin SODIMM up to 32GB Dual Channel DDR4 1866/2133MHz
	<b>BIOS</b>	Insyde SPI 128Mbit
<b>GRAPHICS</b>	<b>Controller</b>	Intel® HD Gen 9 Graphics
	<b>Feature</b>	OpenGL 5.0, DirectX 12, OpenCL 2.1 HW Decode: AVC/H.264, MPEG2, VC1/WMV9, JPEG/MJPEG, HEVC/H265, VP8, VP9 HW Encode: MPEG2, AVC/H264, JPEG, HEVC/H265, VP8, VP9
	<b>Display</b>	1 x VGA 1 x DVI (DVI-D signal)/HDMI (HDMI available upon request) 1 x HDMI/DP (DP available upon request) VGA: resolution up to 1920x1200 @ 60Hz DVI: resolution up to 2560x1600 @ 60Hz HDMI: resolution up to 4096x2160 @ 24Hz or 2560x1600 @ 60Hz DP: resolution up to 4096x2304 @ 60Hz
	<b>Triple Displays</b>	VGA + DVI (DVI-D signal) + HDMI VGA + DVI (DVI-D signal) + DP VGA + 2 HDMI VGA + HDMI + DP
<b>STORAGE</b>	<b>Internal</b>	1 x 2.5" SATA 3.0 Drive Bay
<b>EXPANSION</b>	<b>Interface</b>	1 x Full-size Mini PCIe (PCIe/USB) 1 x Half-size Mini PCIe (USB/mSATA) 1 x CFast Card Slot
	<b>ETHERNET</b>	<b>Controller</b> 1 x Intel® I211AT PCIe (10/100/1000Mbps) 1 x Intel® I219V with iAMT11.0 PCIe (10/100/1000Mbps) (only Core i7/i5 supports iAMT)
<b>LED</b>	<b>Indicators</b>	1 x Power LED 1 x HDD LED
<b>FRONT I/O</b>	<b>Serial</b>	2 x RS-232/422/485 (DB-9) (RS-232 with power) 2 x RS-232/422/485 (DB-9)
	<b>USB</b>	2 x USB 2.0 (type A)
	<b>Buttons</b>	1 x Power Button 1 x Reset Button
<b>REAR I/O</b>	<b>Ethernet</b>	2 x GbE (RJ-45)
	<b>USB</b>	4 x USB 3.0 (type A)
	<b>Display</b>	1 x VGA 1 x DVI (DVI-D signal)/HDMI (HDMI available upon request) 1 x HDMI/DP (DP available upon request)
	<b>Audio</b>	1 x Line-out 1 x Mic-in
<b>WATCHDOG TIMER</b>	<b>Output &amp; Interval</b>	System Reset, Programmable via Software from 1 to 255 Seconds
<b>POWER</b>	<b>Type</b>	Wide Range 9~36V
	<b>Connector</b>	3-pole Terminal Block
<b>OS SUPPORT</b>		Windows 7 (32/64-bit) Windows 10 Windows 8.1 (64-bit)
<b>MECHANISM</b>	<b>Construction</b>	Aluminum + SGCC
	<b>Mounting</b>	Wall Mount
	<b>Dimensions (W x H x D)</b>	235mm x 63.2mm x 221.2mm (W x H x D)
	<b>Weight</b>	3.5 kg
<b>ENVIRONMENT</b>	<b>Operating Temperature</b>	0 to 50°C (SSD or mSATA-mini or CFast card, with 0.7m/s air flow)
	<b>Storage Temperature</b>	-20 to 85°C
	<b>Relative Humidity</b>	5 to 95% RH (non-condensing)
<b>STANDARDS AND CERTIFICATIONS</b>	<b>Shock</b>	Half sine wave 3G, 11ms, 3 shock per axis
	<b>Vibration</b>	IEC68-2-64
	<b>Certification</b>	CE, FCC Class A, RoHS

Wall Mounting

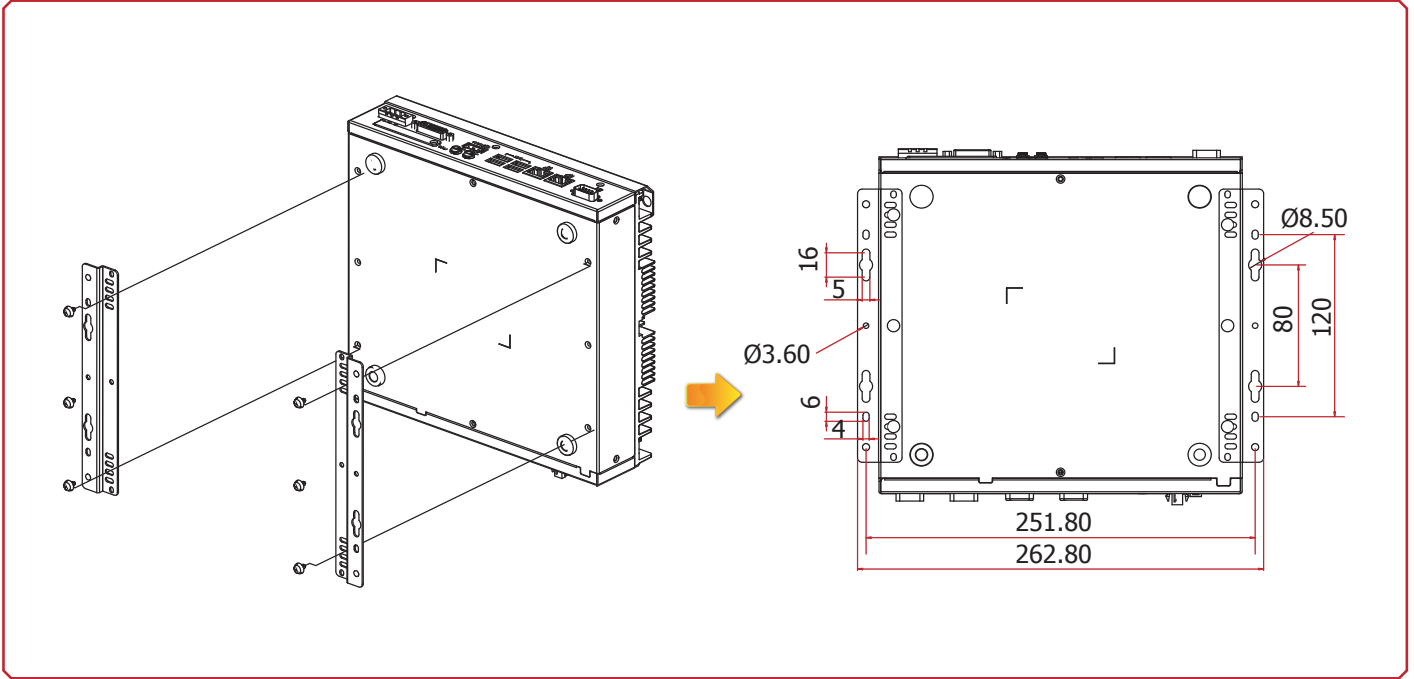

### ► Ordering Information

Model Name	Part Number	Description
EC500-SD4061	750-EC5000-100G	Fanless, Q170, 1 VGA, 1 DVI, 1 HDMI, 2 LAN, 4 COM, 6 USB, RoHS

### ► Optional Items

Optional Items	Part Number	Description
<b>CPU</b>	143-102402-500G	Intel® Core™ i7-6700TE, Quad Core, 8M Cache, 2.4GHz (3.4GHz), 35W, RoHS
	143-102303-500G	Intel® Core™ i5-6500TE, Quad Core, 6M Cache, 2.3GHz (3.3GHz), 35W, RoHS
	143-102701-500G	Intel® Core™ i3-6100TE, Dual Core, 4M Cache, 2.7GHz, 35W, RoHS
<b>Memory</b>	785-RSOD416G	SODIMM, DDR4 Module, 16GB, RoHS
	785-RSOD48G	SODIMM, DDR4 Module, 8GB, RoHS
	785-RSOD44G	SODIMM, DDR4 Module, 4GB, RoHS
<b>mSATA-mini</b>	785-MS128GMF	mSATA Card, 128GB MLC, RoHS
	785-MS64GMF	mSATA Card, 64GB MLC, RoHS
	785-MS32GMF	mSATA Card, 32GB MLC, RoHS
	785-MS16GMF	mSATA Card, 16GB MLC, RoHS
	785-MS08GMF	mSATA Card, 8GB MLC, RoHS
	785-MS04GMF	mSATA Card, 4GB MLC, RoHS
<b>Wi-Fi</b>	761-110091-000G	Wi-Fi Kit, RoHS
<b>Power Cord</b>	785-PWRD	Power Cord, Standards (USA/EUR/CH), 1.8m, RoHS
<b>Power Adapter</b>	671-110002-100G	100W, 12V, Level 6, RoHS
	671-110003-100G	120W, 19V, Level 6, RoHS
<b>Wall Mount</b>	761-EC5410-000G	Wall Mount Kit, RoHS

### ► Packing List

• 1 EC500 system unit
• 1 Quick Installation Guide
• 1 CD disk includes:
- Drivers / Manual