

# P2102E | 8th Generation Intel® Core™ U Series Expandable Embedded Computer with CDS Technology



- Onboard 8th Generation Intel® Core™ U Series Processor
- 2x DDR4 SO-DIMM Socket, Supports Up to 2400MHz, 64GB
- Supports Triple Independent Display
- Integrated USB 3.2 Gen 2 supports up to 10Gbps
- M.2 E Key Socket for Wireless Module or Intel CRF Module
- Supports Ignition Sensing Function (IGN) (with optional CFM module)
- Supports 2x PoE+ Function (with optional CFM module)
- 1x PCI or 1x PCIe Slot for Add-on Card Expansion: Max. Length 180mm including Bracket (with optional riser card)
- Supports CDS Technology for Convertible Panel PC
- Built-in Two 2W Internal Speakers



## Overview

The P2102E is an expandable embedded computer with onboard 8th generation Intel® Core™ U series processor that brings outstanding computing performance boost up to 84% at a TDP of 15 watts, compared to 6th generation Intel® Core™ U series. To enable faster responsiveness and deal with multi tasks with ease, the computer is equipped with two DDR4 2400 SODIMM sockets for up to 64 GB memory. Powered by Intel® UHD graphics 620, the P2102E supports triple independent displays (CDS/VGA/DisplayPort) and can play 4K UHD video smoothly via DisplayPort.

For expansion requirements, the computer has 1x PCI/PCIe x4, 1x M.2 2230 E key and 2x full-size Mini-PCIe expansions which can be installed various add-on cards to increase desired functions. Besides, the P2102E supports Control Function Module (CFM) Technology to install optional CFM modules for increasing power over ethernet and power ignition sensing functions according to user's specific applications. Featuring rigorous industrial protection, fanless/jumper-less design, wide operating temperature (-40°C to +70°C), wide range DC power input (9~48 VDC), high tolerance for vibration/shock (5/50 Grms), the P2102E is appropriate for harsh environments and critical industrial applications.

Moreover, by taking advantage of Cincoze patented Convertible Display System (CDS) technology, the P2102E is compatible with CDS display modules and can be easily converted to an industrial panel PC of different sizes for selection.

## Highlights



### High Performance Per Watt

Powered by 8th generation Intel® Core™ U series processor (up to 4 cores, 4.10 GHz) at a TDP of only 15W, the P2102E can fulfill a variety of applications that require high-performance computing and low power budget simultaneously.

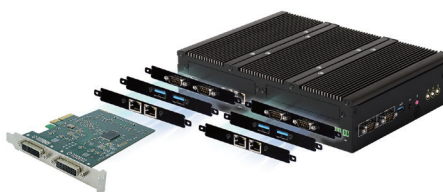

### Flexible Expansions

Featuring 1x PCI/PCIe x4 slot, 1x M.2 2230 E key socket, and 2x full-size Mini-PCIe slots, the P2102E is capable of increasing additional I/O, or expansion cards to match your desired applications, such as data acquisition, motion control, and wireless communication.



### Patented CDS Technology

Based on Cincoze patented Convertible Display System (CDS) technology, the P2102E can be easily converted to an industrial panel PC of different sizes by configuring with a variety of CDS display modules.

## Specifications

### Processor System

- Onboard 8th Intel® Core™ U Processors (Whiskey Lake)
  - Intel® Core™ i5-8365UE Quad Core Processor (6M Cache, up to 4.10 GHz)
  - Intel® Core™ i3-8145UE Dual Core Processor (4M Cache, up to 3.90 GHz)
  - TDP: 15 W

### Memory

- 2x DDR4 2400 MHz 260-Pin SO-DIMM Socket
- Supports up to 64 GB (un-buffered and non-ECC)

### Graphics

- Integrated Intel® UHD Graphics 620
- Supports Triple Independent Display (1x CDS, 1x VGA, 1x DisplayPort)

### Audio Codec

- Realtek ALC888-GR

### External I/O Interface

- 1x VGA (1920 x 1200 @60Hz)
- 1x DisplayPort (4096 x 2304 @ 60Hz)
- 2x GbE LAN (Supports WoL, Teaming, Jumbo Frame & PXE), RJ45
  - GbE1: Intel® I219-LM
  - GbE2: Intel® I210
- 3x USB 3.2 Gen2 (Type A)
- 2x USB 2.0 (Type A)
- 4x RS-232/422/485 with Auto Flow Control (Supports 5V/12V), DB9
- 1x Speaker-out & 1x Mic-in, Phone Jack 3.5mm
- 1x ATX Power On/Off Button
- 1x Reset Button
- 1x AT/ATX Mode Switch
- 1x Clear CMOS Switch
- 1x Remote Power On/Off Connector, 2-pin Terminal Block
- 16x Isolated DIO (8x DI/8x DO), 20-Pin Terminal Block
- 1x Ignition DIP Switch (12V/24V, need to work with CFM module)

### Storage

- 2x 2.5" HDD/SSD Drive Bay (SATA 3.0), Supports RAID 0/1

### Expansion

- 2x Full-size Mini-PCIe Socket
- 1x M.2 2230 E Key Socket for Wireless Module, Supports Intel CRF Module
- 2x Control Function Module (CFM) Interface
- 1x Convertible Display System (CDS) Interface
- 1x PCI or 1x PCIe x4 Expansion slot (with Optional Riser Card)
- 2x Universal I/O Bracket
- 1x Front Accessible SIM Socket
- 4x Antenna Hole

### Other Functions

- Watchdog Timer: Software Programmable Supports 256 Levels System Reset
- Internal Speaker AMP 2W + 2W
- OSD Function: LCD On/Off, Brightness Up, Brightness Down
- SuperCap Integrated for CMOS Battery Maintenance-free Operation
- Supports Instant Reboot Technology (0.2 sec)

### Power Requirement

- Supports AT/ATX Power Type
- Power Input Voltage 9~48VDC
- 1x 3-pin Terminal Block
- Power Adapter (Optional): AC/DC 12V/5A 60W, AC/DC 24V/5A 120W or AC/DC 24V/9.2A 220W

### Physical

- Dimension (WxDxH, mm): 254.5 x 190 x 61 mm
- Weight: 2.7 kg
- Construction: Extruded Aluminum with Heavy Duty Metal
- Mounting: Wall / VESA / CDS / DIN Rail
- Fanless Design
- Jumper-less Design

### Environment

- Operating Temperature: -40°C to 70°C (with Extended Temperature Peripherals; Ambient with Air Flow)
- Storage Temperature: -40°C to 70°C
- Relative Humidity: 95% RH @ 70°C (Non-condensing)
- Shock: Operating, 50 Grms, Half-sine 11 ms Duration (w/ SSD, according to IEC60068-2-27)
- Vibration: Operating, 5 Grms, 5-500 Hz, 3 Axes (w/ SSD, according to IEC60068-2-64)
- EMC: CE, FCC Class A
- Safety: LVD (EN62368-1)
- MTBF: 231,243 hours

### Protection

- Reverse Power Input Protection
- Over Voltage Protection:
  - Protection Range: 51~58V
  - Protection Type: shut down operating voltage, re-power on at the preset level to recover
- Over Current Protection: 15A
- ESD Protection: +/-8kV (air), +/-4kV (contact)
- Surge Protection: 2 kV

### Operating System

- Windows® 10
- Linux: Supports by project

**External Layout**

Front I/O

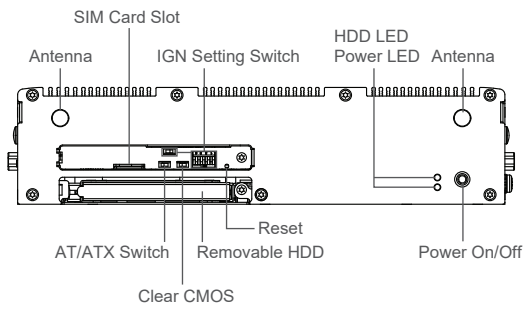

Rear I/O

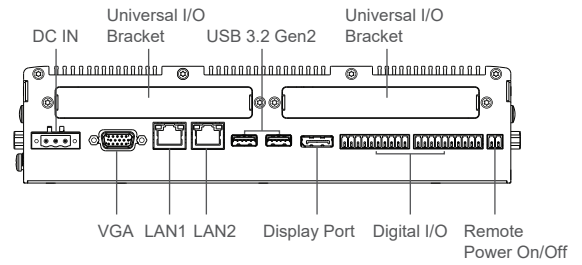

Left I/O

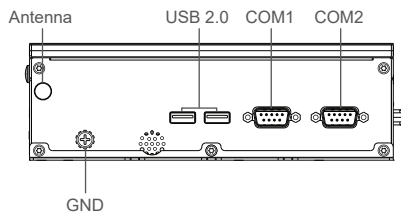

Right I/O

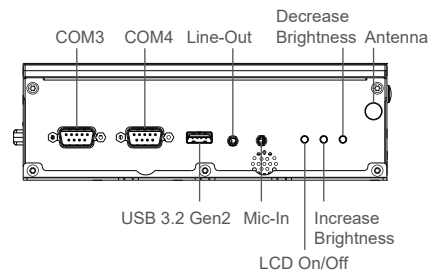

**Dimensions**

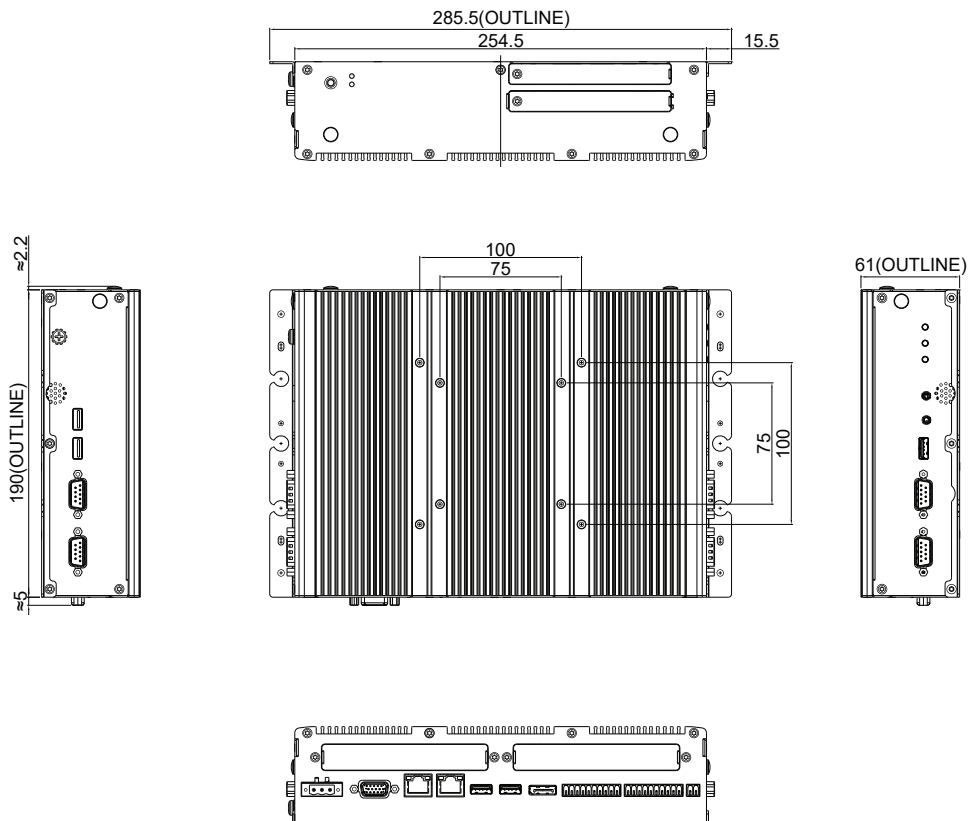

Unit: mm

## Ordering Information

### Available Models

Model No.	Description
P2102E-i5-R10	8th Generation Intel® Core™ i5-8365UE Quad Core Expandable Embedded Computer with CDS Technology
P2102E-i3-R10	8th Generation Intel® Core™ i3-8145UE Dual Core Expandable Embedded Computer with CDS Technology

### Package Checklist

- P2102E Embedded System x 1
- Thermal Pad (for CPU Thermal Block) x 1
- Power Terminal Block Connector x 1
- Remote Power On/Off Terminal Block Connector x 1
- DIO Terminal Block Connector x 2
- Utility Driver DVD x 1
- Screws Pack x 5
- Wall / CDS Mounting Kit x 1
- DIN Rail Mountng Kit x 1
- PCI / PCIe Card Installation Kit x 1

### Optional Modules & Accessories

Model No.	Description
CFM-IGN101	CFM Module with Power Ignition Sensing Control Function, 12V/24V Voltage Detection Selectable
CFM-PoE05	CFM Module with PoE Control Function, Individual Port 25.5W
RC-E4-02	Riser Card with 1x PCIe x4 Slot for P2102E
RC-PI-02	Riser Card with 1x PCI Slot for P2102E
MEC-COM-M212-TDB9/UB1203	Mini-PCIe Module with 2x RS-232 Ports, 1x Thin DB9 Cable / 1x Universal Bracket with 2x DB9 Cutout for P2102E
MEC-COM-M334-TDB9/2xUB1203	Mini-PCIe Module with 4x RS-232/422/485 Ports, 2x Thin DB9 Cable / 2x Universal Bracket each with 2x DB9 Cutout for P2102E
MEC-USB-M102-30/UB1214	Mini-PCIe Module with 2x USB 3.0 Ports, 1x 30cm cable / 1x Universal Bracket with 2x USB Cutout for P2102E
MEC-LAN-M102-30/UB1211	Mini-PCIe Module with 2x LAN Ports, 2x 30cm cable / 1x Universal Bracket with 2x RJ45 Cutout for P2102E
GST60A12-CIN1	Adapter AC/DC 12V 5A 60W, GST60A12-CIN, wide temp (-30°C ~ +70°C), level VI
GST120A24-CIN	Adapter AC/DC 24V 5A 120W, GST120A24-CIN, wide temp (-30°C ~ +70°C), level VI
GST220A24-CIN	Adapter AC/DC 24V 9.2A 220W with 3pin Terminal Block Plug 5.0mm Pitch, with TUBES, level VI
SL2-SL3	US 2 heads power cord, US B type to IEC C13, SVT 18AWG/3C Black 1.8M SL-2+SL-3
SL6-SL3	EU 2 heads power cord, EU G type to IEC C13, H05VV-F 0.75mm2/3G Black 1.8M SL-6+SL-3
QP026-SL3	UK 2 heads power cord, UK I type to IEC C13, H05VV-F 0.75mm2/3G Black 1.8M QP026+SL-3

## CDS Display Module Compatible Table

Panel Size (inches)	Resolution	Brightness (nits)	Touch Type	Display Module
12.1	800 x 600 (SVGA)	450	Resistive/ P-Cap.	CV-112
	1024 x 768 (XGA)	500	Resistive/ P-Cap.	CV-112H
	1024 x 768 (XGA)	1,500	P-Cap.	CS-112H
15	1024 x 768 (XGA)	350	Resistive/ P-Cap.	CV-115
	1024 x 768 (XGA)	1,600	P-Cap.	CS-115
15.6	1366 x 768 (WXGA)	400	Resistive/ P-Cap.	CV-W115
17	1280 x 1024 (SXGA)	350	Resistive/ P-Cap./ Glass Only	CV-117
	1280 x 1024 (SXGA)	1,500	P-Cap.	CS-117
19	1280 x 1024 (SXGA)	350	Resistive/ P-Cap./ Glass Only	CV-119
	1280 x 1024 (SXGA)	1,600	P-Cap.	CS-119
21.5	1920 x 1080 (Full HD)	300	Resistive/ P-Cap./ Glass Only	CV-W121
24	1920 x 1080 (Full HD)	300	Resistive/ P-Cap./ Glass Only	CV-W124

## Optional Module Configuration

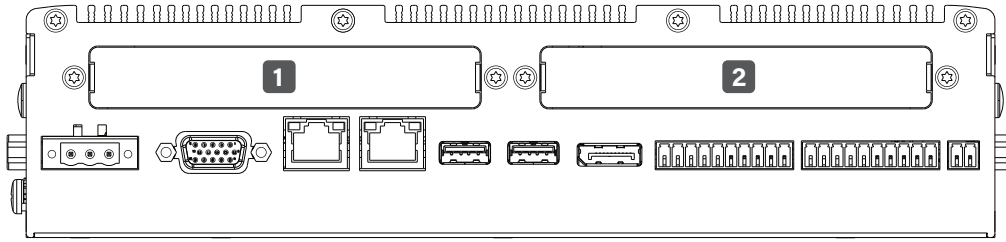

Model No.	Description	1	2
RC-E4-02	Riser Card with 1x PCIe x4 Slot for P2102E	V	-
RC-PI-02	Riser Card with 1x PCI Slot for P2102E	V	-
MEC-COM-M212-DB9/UB1203	Mini-PCIe Module with 2x RS-232 Ports, 1x Thin DB9 Cable / 1x Universal Bracket with 2x DB9 Cutout for P2102E	V	V
MEC-COM-M334-TDB9/2xUB1203	Mini-PCIe Module with 4x RS-232/422/485 Ports, 2x Thin DB9 Cable / 2x Universal Bracket each with 2x DB9 Cutout for P2102E	V	V
MEC-USB-M102-30/UB1214	Mini-PCIe Module with 2x USB 3.0 Ports, 1x 30cm cable / 1x Universal Bracket with 2x USB Cutout for P2102E	V	V
MEC-LAN-M102-30/UB1211	Mini-PCIe Module with 2x LAN Ports, 2x 30cm cable / 1x Universal Bracket with 2x RJ45 Cutout for P2102E	V	V

V : Compatible