

CS-112H/P2000

12.1" TFT-LCD Sunlight Readable Touch Panel PC with 6th Gen. Intel® Core™ Processor



- 12.1" TFT-LCD with Ultra High Brightness up to 1,500 nits and 1024 x 768 (XGA) Resolution
- Onboard Intel® 6th Generation Core™ Processor U Series (15W)
- Supports 2x DDR4 SO-DIMM Socket, up to 32 GB
- Integrated Intel® HD Graphics 520, Triple Display Support
- 2x 2.5" SATA Drive Bay, 1x mSATA, and 1x CFast Socket
- Rich I/O (2x GbE LAN, 6x COM, 5x USB, 16x Isolated DIO)
- 2x Full-size Mini-PCle Socket for Wireless and I/O Expansion
- Wide Range Operating Temperature -20°C to 70°C
- Designed with Aluminum Die-casting Front Frame
- True Flat IP65 Front Panel Protection
- Supports Panel / VESA / Rack Mounting
- Convertible Display System (CDS) Technology Supported

Overview

CS-112H/P2000 Series is a 12.1" TFT-LCD sunlight readable touch panel PC offering 1,500 nits ultra high brightness and 1024 x 768 (XGA) resolution. The system is equipped with high-performance Intel® 6th generation Core™ U series processor and provides extensive I/O including 2x GbE, 5x USB, 6x RS232/422/485, 8x DI/8x DO, 1x VGA and 1x DVI-D. It also supports 2x Mini-PCle slot and 1x SIM socket for a variety of wireless connections, such as BT/WiFi and 3G/LTE. In addition, there are 3 types of storage devices including 2.5" SATA HDD (RAID 0/1), mSATA and CFast. The accessible design of these storage devices allows quick data access and easy maintenance.

CS-112H/P2000 Series supports Convertible Display System (CDS) technology. Comparing to regular standalone panel PCs, it can lower maintenance cost and reduce unplanned downtime.

For greater flexibility, CS-112H/P2000 Series has PCI/PCle expandable version and PoE/power ignition functions by additional CFM (Control Function Module). Furthermore, CS-112H/P2000 Series is a truly rugged display system supporting wide range operating temperature (-20°C to 70°C), IP65 dust/waterproof front panel, wide range DC power input (9 to 48VDC) and rigorous industrial protections.

Highlights



Sunlight Readable

Providing ultra high brightness 1,500 nits and resolution up to 1024 x 768 (XGA), CS-112H/P2000 Series is suitable for all lighting conditions including direct sunlight.



High Performance

Powered by Intel® 6th Gen. Core™ Processor U Series, CS-112H/P2000 Series Panel PC has greatly increased computing performance and power efficiency.



Wide Temperature

CS-112H/P2000 Series supports wide range operating temperature from -20°C to 70°C and is suitable for deploying in extreme and harsh environments.

Specifications

Display

- LCD Size: 12.1" (4:3)
- Max. Resolution: 1024 x 768
- Brightness (cd/m²): 1500
- Contrast Ratio: 700 : 1
- LCD Color: 16.2M
- Pixel Pitch (mm): 0.24 (H) x 0.24 (V)
- Viewing Angle (H-V): 160 / 160
- Backlight MTBF: 30,000 hrs (LED Backlight)

Touch

- Projected Capacitive Touch

Processor System

- Onboard 6th Intel® Core™ U processors (Skylake)
 - Intel® Core™ i5-6300U processor (3M Cache, up to 3.00 GHz)
 - Intel® Core™ i3-6100U processor (3M Cache, 2.30 GHz)
 - TDP: 15 W
 - BIOS: AMI 64Mbit SPI BIOS

Memory

- 2x DDR4 260-pin SO-DIMM socket, support up to 32 GB (2133MHz, un-buffered and non-ECC type)

Graphics

- Intel® HD Graphics 520
- Triple display with 1x VGA, 1x DVI-D and 1x CDS interface

Audio

- Realtek® ALC888-GR
- High Definition Audio

I/O Interface

- 1x VGA (Up to 1920 x 1080 @ 60Hz), DB-15
- 1x DVI-D (Up to 1920 x 1080 @ 60Hz)
- 1x CDS Interface, Compact PCI Connector
- 2x GbE LAN (Support WoL, Teaming, Jumbo Frame and PXE), RJ45
 - GbE1: Intel I219LM
 - GbE2: Intel I210
- 2x PoE+ (with Optional CFM PoE Module)
 - Comply with IEEE 802.3at, Offers Up to 25.5W Per Port
- 6x RS-232/422/485 with Auto Flow Control (Supports 5V/12V), DB9
- 4x USB 3.0, Type-A
- 1x USB 2.0, Type-A
- 16x Isolated DIO (8x DI/8x DO), 20-Pin Terminal Block
- 1x Line-out & 1x Mic-in, Phone Jack 3.5mm
- 1x Power On/Off Switch
- 1x Reset Button
- 1x AT/ATX Switch
- 1x Remote Power On/Off Connector, 2-Pin Terminal Block
- 1x External FAN Connector, 4-Pin Terminal Block

Expansion

- 1x CFM PoE interface
- 1x CFM IGN interface
- 1x PCI or 1x PCIe4 Expansion slot [CS-112HC/P2002E]
 - Optional Riser Card: 1x PCI, 1x PCIe4
 - Support maximum dimension of add-on card (H x L): 100mm x 200mm
- 2x Full-size Mini-PCIe Socket
- 1x Universal I/O Bracket
- 1x SIM Socket
- 4x Antenna Hole

Storage

- 2x 2.5" SATA Drive Bay, Supports RAID 0/1 (Gen3)
- 2x mSATA (One Shared by Mini-PCIe Socket) (Gen2)
- 1x CFast Socket

Other Function

- Supports CDS Technology
- Supports CFM Technology
- Supports Instant Reboot Technology (0.2 sec)
- Supports Power Ignition Sensing (IGN)
- Support OSD Function
 - (LCD On/Off, Brightness Up, Brightness Down for CDS Display Module)
- Internal Speaker AMP 2W + 2W
- SuperCap Integrated
- Watchdog Timer:
 - Software Programmable Supports 256 Levels System Reset

Power Requirement

- Supports AT/ATX Power Mode
- Power Input Voltage 9~48VDC
- One 3-pin Terminal Block Connector
- Power Adapter AC/DC 24V/5A 120W or 24V/9.2A 220W (Optional)

Physical

- Dimensions (WxHxD): CS-112HC/P2002: 345 x 265.3 x 82 mm
CS-112HC/P2002E: 345 x 265.3 x 100 mm
- Weight: CS-112HC/P2002: 6.08 kg
CS-112HC/P2002E: 6.34 kg
- Front Panel Construction: Flat Rugged Aluminum Die-casting Bezel
- Supports Panel / VESA / *Rack Mounting (*with optional mounting kit)
- Fanless Design
- Jumper-less Design

Environment

- Operating Temperature: -20°C to 70°C
 - (With extended temperature peripherals; Ambient with air flow According to IEC60068-2-1, IEC60068-2-2, IEC60068-2-14)
- Storage Temperature: -20°C to 70°C
- Relative Humidity: 80% RH @ 40°C (Non-condensing)
- Shock: Operating, 15 Grms, Half-sine 11 ms Duration
 - (w/ SSD, according to IEC60068-2-27)
- Vibration: Operating, 1.5 Grms, 5-500 Hz, 3 Axes
 - (w/ SSD, according to IEC60068-2-64)
- IP Level: IP65 Compliant Front Panel
- EMC: CE, FCC Class A

Protection

- Reverse Power Input Protection
- Over Voltage Protection:
 - Protection Range: 51~58V
 - Protection Type: shut down operating voltage, re-power on at the preset level to recover
- Over Current Protection: 15A
- ESD Protection: +/-8kV (air), +/-4kV (contact)
- Surge Protection: 3kW

Operating System

- Windows® 10
- Windows® 8.1
- Windows® 7

Certification

- CE
- FCC Class A

External Layout

CS-112H/P2002

Front

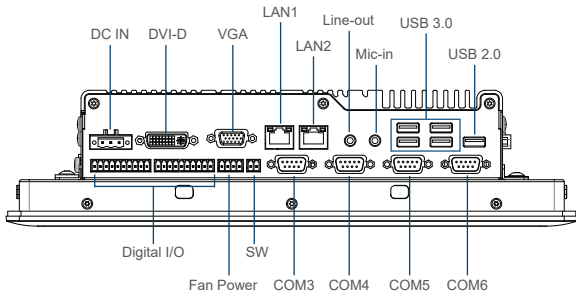

Rear

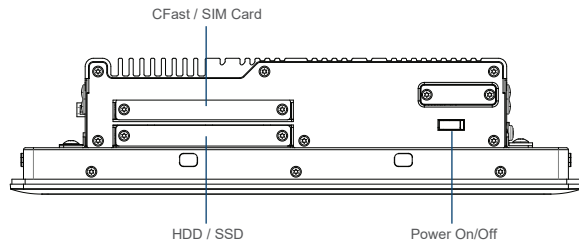

Left

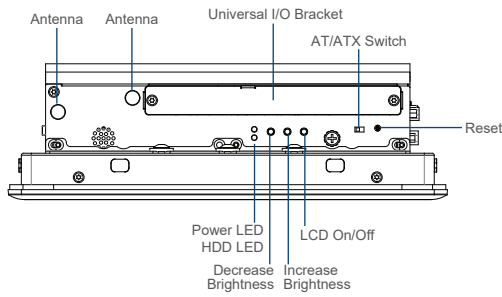

Right

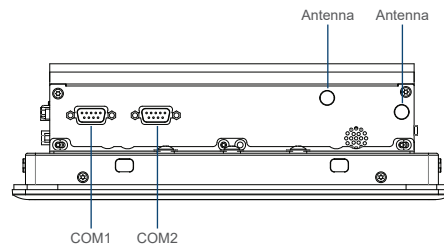

CS-112H/P2002E

Front

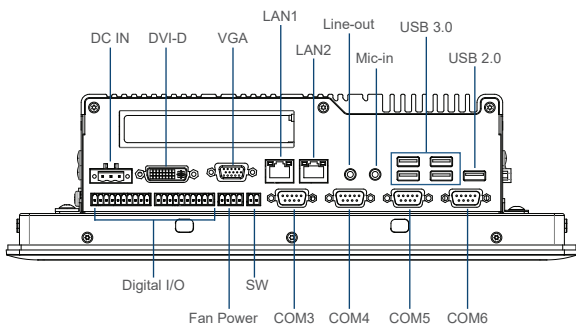

Rear

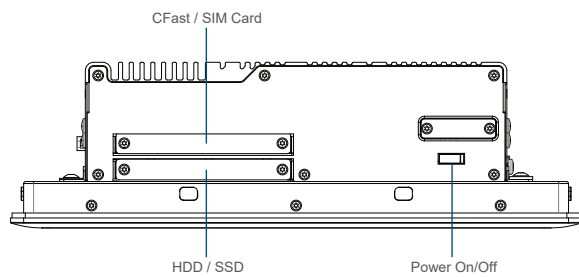

Left

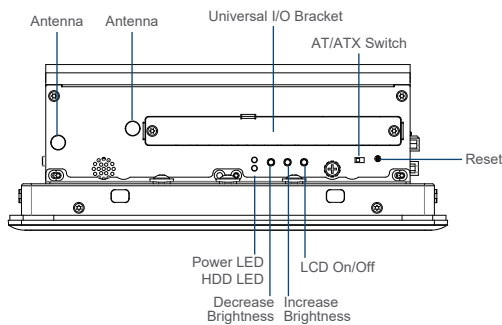

Right

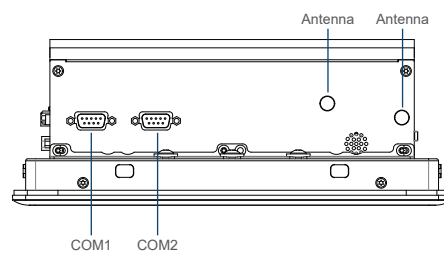

Dimensions

CS-112H/P2002

Unit: mm

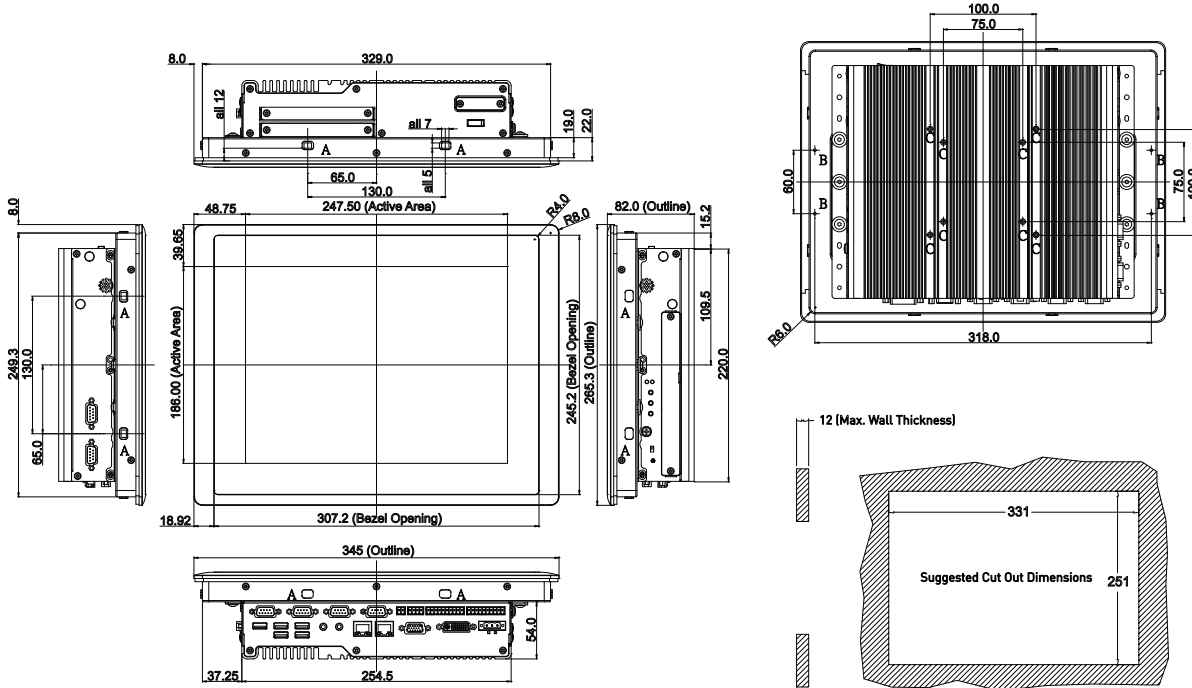

CS-112H/P2002E

Unit: mm

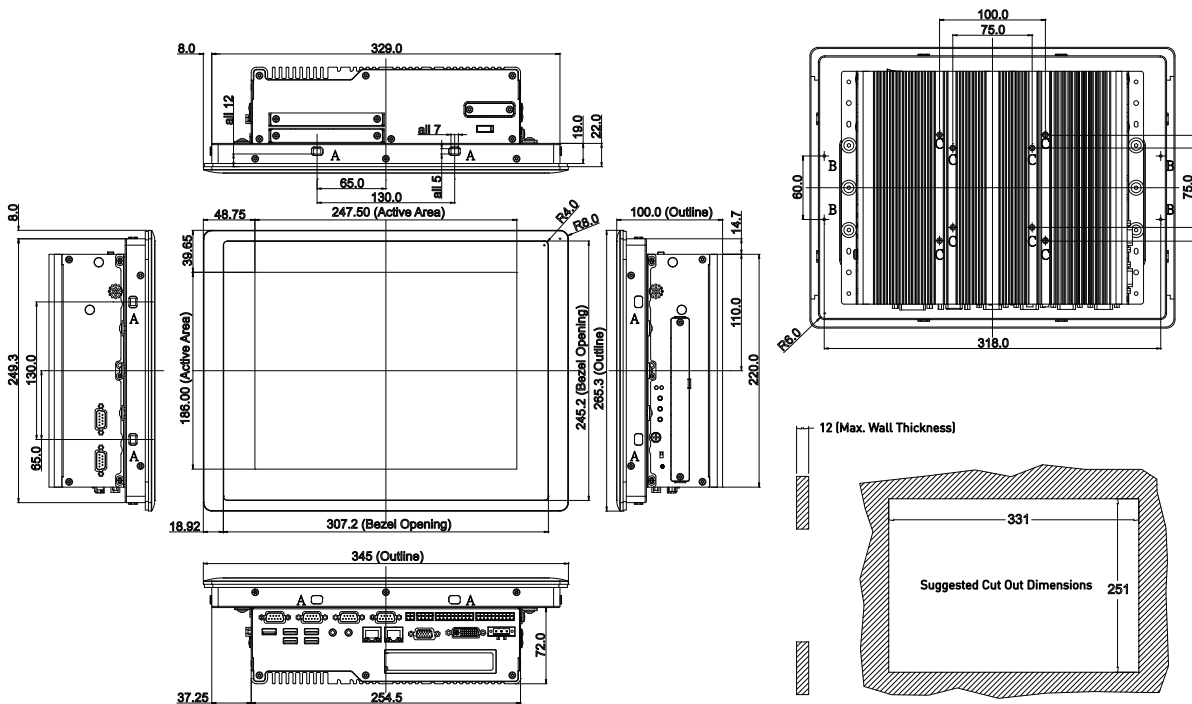

Ordering Information

Available Models

Model No.	Description
CS-112HC-R10/P2002-i5-R10	12.1" TFT-LCD 1500 nits Sunlight Readable Touch Panel PC with Intel® Core™ i5-6300U Processor and P-Cap. Touch
CS-112HC-R10/P2002E-i5-R10	12.1" TFT-LCD 1500 nits Sunlight Readable Touch Panel PC with Intel® Core™ i5-6300U Processor, P-Cap. Touch and 1x Reserved Expansion Slot
CS-112HC-R10/P2002E-i5-E4-R10	12.1" TFT-LCD 1500 nits Sunlight Readable Touch Panel PC with Intel® Core™ i5-6300U Processor, P-Cap. Touch and 1x PCIe x4 Expansion Slot
CS-112HC-R10/P2002E-i5-PI-R10	12.1" TFT-LCD 1500 nits Sunlight Readable Touch Panel PC with Intel® Core™ i5-6300U Processor, P-Cap. Touch and 1x PCI Expansion Slot
CS-112HC-R10/P2002-i3-R10	12.1" TFT-LCD 1500 nits Sunlight Readable Touch Panel PC with Intel® Core™ i3-6100U Processor and P-Cap. Touch
CS-112HC-R10/P2002E-i3-R10	12.1" TFT-LCD 1500 nits Sunlight Readable Touch Panel PC with Intel® Core™ i3-6100U Processor, P-Cap. Touch and 1x Reserved Expansion Slot
CS-112HC-R10/P2002E-i3-E4-R10	12.1" TFT-LCD 1500 nits Sunlight Readable Touch Panel PC with Intel® Core™ i3-6100U Processor, P-Cap. Touch and 1x PCIe x4 Expansion Slot
CS-112HC-R10/P2002E-i3-PI-R10	12.1" TFT-LCD 1500 nits Sunlight Readable Touch Panel PC with Intel® Core™ i3-6100U Processor, P-Cap. Touch and 1x PCI Expansion Slot

Optional Modules

Model No.	Description
CFM-IGN100	CFM Module with Power Ignition Sensing Control Function, 12V/24V Selectable (41 x 35 mm)
CFM-PoE100	PoE Control Function Module, Individual Port 25.5W (50 x 44 x 15 mm) (For CS-100/P2002 only)
CFM-PoE101	PoE Control Function Module, Individual Port 25.5W (50 x 44 x 33 mm) (For CS-100/P2002E only)
MEC-COM-M212/UB0503	Mini-PCIe Module with 2x COM Ports, 2x Universal Brackets (154 x 17 mm)
MEC-COM-M334/UB0504	Mini-PCIe Module with 4x RS-232/422/485 Serial Ports, 1x Universal Bracket (154 x 17 mm)
MEC-LAN-M102-30/UB0511	Mini-PCIe Module with 2x LAN Ports, 2x 30cm cable / 1x Universal Bracket with 2x RJ45 Cutout for P2000 Series
MEC-USB-M002/UB0514	Mini-PCIe Module with 2x USB 3.0 Ports, 1x Universal Bracket (154 x 17 mm)
RC-E4-01	Riser Card with 1x PCIe4 Slot (For CS-100/P2002E only)
RC-PI-01	Riser Card with 1x PCI Slot (For CS-100/P2002E only)

Optional Accessories

Model No.	Description
GST120A24-CIN	Adapter AC/DC 24V 5A 120W, GST120A24-CIN, wide temp (-30°C ~ +70°C), level VI
GST220A24-CIN	Adapter AC/DC 24V 9.2A 220W with 3pin Terminal Block Plug 5.0mm Pitch, with TUBES, GST220A24-CIN
SL2-SL3	US 2 heads power cord, US B type to IEC C13,SVT 18AWG/3C Black 1.8M
SL6-SL3	EU 2 heads power cord, EU G type to IEC C13,H05VV-F 0.75mm2/3G Black 1.8M
QP026-SL3	UK 2 heads power cord, UK I type to IEC C13,H05VV-F 0.75mm2/3G Black 1.8M
URM01	Universal 19" Rack Mount Kit for Industrial Panel PC & Industrial Monitor

Package Checklist

- Panel PC x 1
- Utility DVD Driver x 1
- Power Terminal Block Connector x 1
- Fan Terminal Block Connector x 1
- DIO Terminal Block Connector x 2
- Power On/Off Terminal Block Connector x 1
- Screw Pack x 1
- Panel Mounting Kit x 1