

EC500-CS

Q370
H310
C246



8th/9th Gen Intel® Core™
Modular-Designed Embedded System



KEY FEATURES



DDR4

DDR4 SODIMM up to 64GB



Wide-Temperature

Operating temperature: -20 to 70°C



Three Independent Displays

1 VGA + 2 HDMI/DP++ (auto detection)

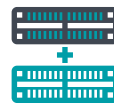

Multiple Expansion

3 M.2 slots (1 M.2 2230 E key, 1 M.2 3042/3052 B key, 1 M.2 2280 M key)

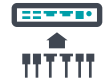

Rich I/O

2 GbE, 6 COM, 4 USB 3.1, 2 USB 2.0 (Q370/C246 only)



Support 5G Communication

Support 5G communication



PANEL

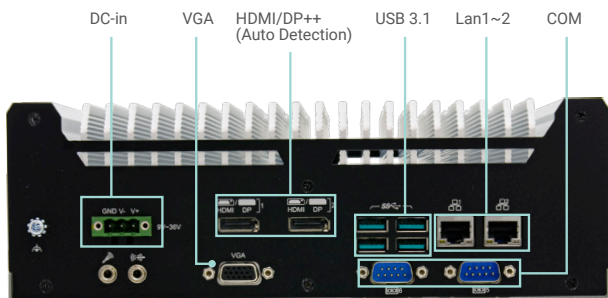

Front View

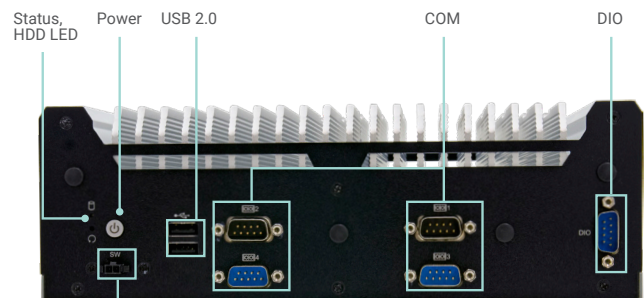

Rear View

DIMENSIONS

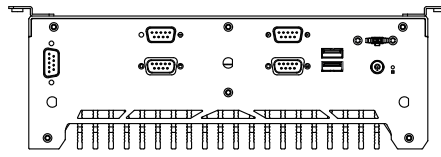

Front View

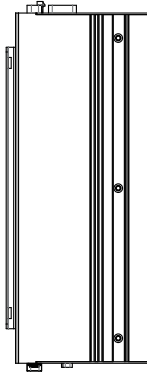

Left View

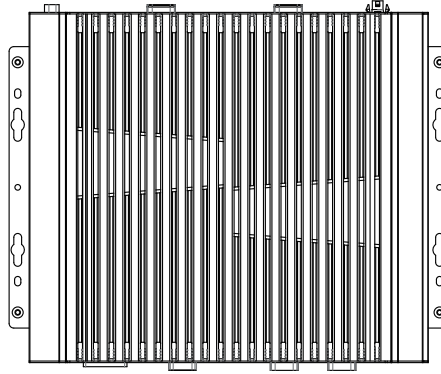

224.00

Right View

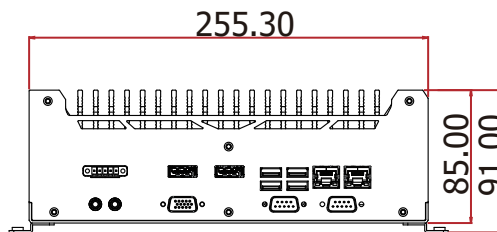

Rear View

WALL MOUNTING

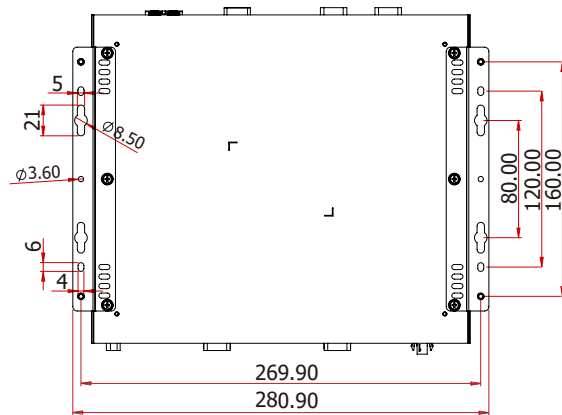
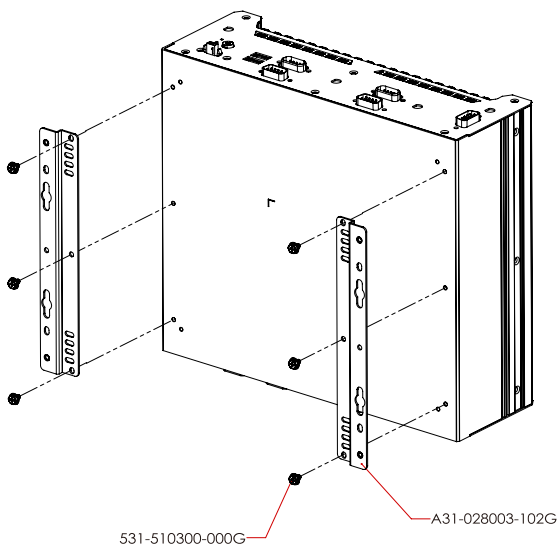

SPECIFICATION

SYSTEM	Processor	8th/9th Generation Intel® Core™ Processors, LGA 1151 Intel® Core™ i7-9700TE , Octa Cores, 12M Cache, up to 3.8 GHz, 35W Intel® Core™ i5-9500TE , Hexa Cores, 9M Cache, up to 3.6 GHz), 35W Intel® Core™ i3-9100TE, Quad Cores, 6M Cache, up to 3.2 GHz, 35W Intel® Core™ i7-8700T Processor, Hexa Core, 12M Cache, 2.4GHz (4GHz), 35W Intel® Core™ i5-8500T Processor, Hexa Core, 9M Cache, 2.1GHz (3.5GHz), 35W Intel® Core™ i3-8100T Processor, Quad Core, 6M Cache, 3.1GHz, 35W Intel® Pentium® Processor G5400T, Dual Core, 4M Cache, 3.1GHz, 35W Intel® Celeron® Processor G4900T, Dual Core, 2M Cache, 3.1GHz, 35W
	Chipset	Intel® Q370/C246/H310 Chipset
	Memory	Two 260-pin DDR4 2400/2666MHz SODIMM up to 64GB
	BIOS	Insyde SPI 128Mbit
	GRAPHICS	Controller
	Feature	OpenGL up to 5.0, DirectX 11, OpenCL 2.1 HW Decode: HEVC/H.265, H.264, M/JPEG, MPEG2, VC1/WMV9, VP8 (8-bit), VP9 (10-bit) HW Encode: HEVC/H.265, M/JPEG, MPEG2, VP8
	Display	Q370/C246: 1 x VGA 2 x HDMI/DP++ (auto detection) H310: 1 x VGA 1 x HDMI/DP++ (auto detection) VGA: resolution up to 1920x1200 @ 60Hz HDMI: resolution up to 4096x2160 @ 30Hz DP++: resolution up to 4096x2304 @ 60Hz
	Dual/Triple Displays	Q370/C246: 1 x VGA + 2 x HDMI/DP++ (auto detection) H310: 1 x VGA + 1 x HDMI/DP++ (auto detection)
STORAGE	Internal	2 x 2.5" SATA 3.0 Drive Bay support RAID 0/1
EXPANSION	Interface	Q370/C246: 1 x M.2 2230 E key (PCIe/USB 2.0) 1 x M.2 2280 M key (PCIe x4 NVMe/SATA) 1 x M.2 3042/3052 B key (PCIe/USB3.0) H310: 1 x M.2 2230 E key (PCIe/USB 2.0) 1 x M.2 2280 M key (SATA) 1 x M.2 3042/3052 B key (PCIe)
AUDIO	Audio Codec	Realtek ALC888
ETHERNET	Controller	Q370/C246: 1 x Intel® I211AT PCIe (10/100/1000Mbps) 1 x Intel® I219LM with iAMT11.0 PCIe (10/100/1000Mbps) (only Core i7/i5 supports iAMT) H310: 1 x Intel® I211AT PCIe (10/100/1000Mbps) 1 x Intel® I219V PCIe (10/100/1000Mbps)
LED	Indicators	1 x Status LED 1 x HDD LED
FRONT I/O	Serial	4 x RS-232/422/485 (DB-9)
	USB	2 x USB 2.0 (type A)
	DIO	8 bit (DB-9)
	Buttons	1 x Power button 1 x Reset button
	Antenna	4 x Antenna hole
REAR I/O	Ethernet	2 x GbE (RJ-45)
	Serial	2 x RS-232 (DB-9)
	USB	4 x USB 3.1 (type A)
	Display	Q370/C246: VGA + 2 x HDMI/DP++ (auto detection) H310: VGA + 1 x HDMI/DP++ (auto detection)
	Audio	1 x Line-out 1 x Mic-in
WATCHDOG TIMER	Output & Interval	System reset, programmable via software from 1 to 255 seconds
SECURITY	TPM	TPM 2.0
POWER	Type	Wide range 9~36V
	Connector	3-pole terminal nlock 3-pin power extension switch connector
OS SUPPORT	Window	Windows 10 IoT Enterprise 64 Bit
	Linux	Linux (available upon request)

SPECIFICATION

MECHANISM	Construction	Metal + Aluminum
	Mounting	Wall Mount
	Dimensions (W x H x D)	255.3 x 85 x 224mm
	Weight	4.15 kg
ENVIRONMENT	Operating Temperature	-20 to 70°C (SSD or mSATA)
	Storage Temperature	-20 to 85°C
	Relative Humidity	5 to 95% RH (non-condensing)
STANDARDS AND CERTIFICATIONS	Shock	Half sine wave 3G, 11ms, 3 shock per axis
	Vibration	IEC68-2-64
	Certification	CE, FCC Class A

ORDERING INFORMATION

Model Name	Part Number	Description
EC500-CS4061-Q	750-EC5003-000G	EC500-CS4061-Q:Fanless, CS263, Q370, CPU i5-8500T, 6 COM, 6 USB, 1 VGA, 2 HDMI/DP, 2 LAN, 1 Line-out, 1 Mic-in, 8 bits DIO, DC9~36V, F/G SYSTEM RoHS
EC500-CS4061-H	750-EC5003-100G	EC500-CS4061-H:Fanless, CS263, H310, CPU i5-8500T, 6 COM, 6 USB, 1 VGA, 1 HDMI/DP, 2 LAN, 1 Line-out, 1 Mic-in, 8 bits DIO, DC9~36V, F/G SYSTEM RoHS
EC500-CS4061-C	750-EC5003-200G	EC500-CS4061-C:Fanless, CS263, C246, CPU i5-8500T, 6 COM, 6 USB, 1 VGA, 2 HDMI/DP, 2 LAN, 1 Line-out, 1 Mic-in, 8 bits DIO, DC9~36V, F/G SYSTEM RoHS

PACKING LIST

1 EC500-CS system unit
1 M.2 slot & Mini-PCIe slot screws
1 terminal block 5 pole for DC input
1 cable with 2 wire stripped and tinned to DC jack