

# WMP-175

## 17" Atom Dual Core Fanless Medical Panel PC



### Key Features

- Fanless entry level medical grade panel PC
- Anti-bacteria plastic housing and medical 60601-1 3<sup>rd</sup> edition certification
- Atom dual core D525 1.8G CPU / Intel ICH8M chipset
- 17" 1280x1024 380 nits LCD & resistive touch panel
- Front IP65 protection and HDD anti-vibration design
- Integrated 2 watts x 2 speakers
- Optional Bluetooth, I/O cover, anti-bacteria desktop stand & glass
- Support RS485 auto flow control function

### Main System

<b>CPU</b>	· Intel Atom dual core D525 1.8GHz (dual core, 1MB L2 cache) · Support FCBGA559 socket, 13W TDP (Max.)
<b>Chipset</b>	Intel ICH8M
<b>Graphics</b>	· D525 integrated the 3 <sup>rd</sup> generation graphics core · Xilinx XC3S200AN scaler chip for up to 1902 x 1080 full HD
<b>Memory</b>	4GB maximum, x 2 DDR2 SODIMM, up to 800MHz, 1GB/2GB/4GB
<b>Serial SATA</b>	SATA x 1, 150MB/s transfer rate
<b>Serial port</b>	RS232/422/485 x 1 (Support RS485 Auto flow control). RS232 x 1 (Reserve layout for internal RS232 x 4 => one at I/O bottom, three with internal pin head)
<b>USB</b>	USB 2.0, x 7 (x 3 external, x 4 internal)
<b>Audio</b>	Realtek ALC268 audio codec, 2+2 watts amplifier
<b>LAN</b>	Marvell 88E8071 Gigabit Ethernet x 1
<b>BIOS</b>	· Award BIOS, 8M EEPROM · RTC wake up / Wake on LAN / Power on after power failure / PnP / ACPI
<b>Speaker</b>	2 watts x 2 (front bottom)

### LCD Panel

<b>Size</b>	17" 5:4
<b>Resolution</b>	1280 x 1024 (SXGA)
<b>Brightness</b>	380 nits
<b>Contrast</b>	1000:1
<b>Color numbers</b>	16.7M (6-bit x 3 + FRC)
<b>Viewing angle</b>	170 (H) / 160 (V)
<b>Response time</b>	5 ms (R + F)
<b>Backlight</b>	CCFL x 2, 50,000 hours life time

### Touch Panel

<b>Technology</b>	Resistive touch, 5-wire
<b>Light transmittance</b>	81 ± 3%
<b>Hardness</b>	≥ 3H
<b>Touch stylus</b>	No limitation
<b>Resolution</b>	4096 x 4096
<b>Life time</b>	35 million activations

### Storage & Expansion

<b>HDD</b>	2.5" SATA HDD drive bay x 1 + anti-vibration kit, 160GB / 500GB
<b>Expansion slot</b>	· Mini PCIe x 1 (52 pin card-edge type) · Optional PCI-E (x4) or PCI slot x 1 · Crad size: 100 x 260 x 12/2 mm

### I/O & Control Keys

<b>USB</b>	USB 2.0 x 3
<b>COM</b>	DB-9 x 2 (RS232 x 1, RS232/422/485 x 1)
<b>LAN</b>	RJ-45 x 1, Gigabit
<b>Video-out</b>	VGA DB-15 x 1
<b>Audio</b>	Line-out, Microphone-in (3.5 mm phone-jack)
<b>Card reader</b>	None
<b>Power input</b>	DC-in x 1, 12V~28V
<b>Control keys</b>	· Front side, membrane type · Power on/off, Brightness, Audio volume

### Power

<b>Power adaptor</b>	External, 100 watts, 90~264V AC in, 12V DC out, medical grade, 1.2m DC cable
<b>Power consumption</b>	61.2 watts (typical, without any add-ons)

### Mechanical & Environmental

<b>Housing</b>	· Plastic front bezel, rear cover / White color · Antibacterial coating
<b>IP rating</b>	IP65 – front side
<b>Cooling</b>	Fanless design
<b>Mounting</b>	VESA 75 x 75 / 100 x 100 mm
<b>Kensington lock</b>	Yes, x 1 at bottom
<b>Dimension</b>	420 x 360 x 83 mm (W x H x D, w/o stand)
<b>Weight (net)</b>	6.5 Kg (approximate, w/o power adaptor)
<b>Temperature</b>	· Operating – 0°C~40°C . Storage – -20°C~60°C
<b>Humidity</b>	Operating & storage – 10%~90%, non-condensing
<b>Regulatory</b>	· FCC-B, cUL, CE, VCCI · Medical 60601-1 3 <sup>rd</sup> edition (EN 60601-1:2006, ANSI/AAMI ES60601-1:2005, CAN/CSA C22.2 No. 60601-1:08)

# WMP-175

## 17" Atom Dual Core Fanless Medical Panel PC

### Outline Dimension

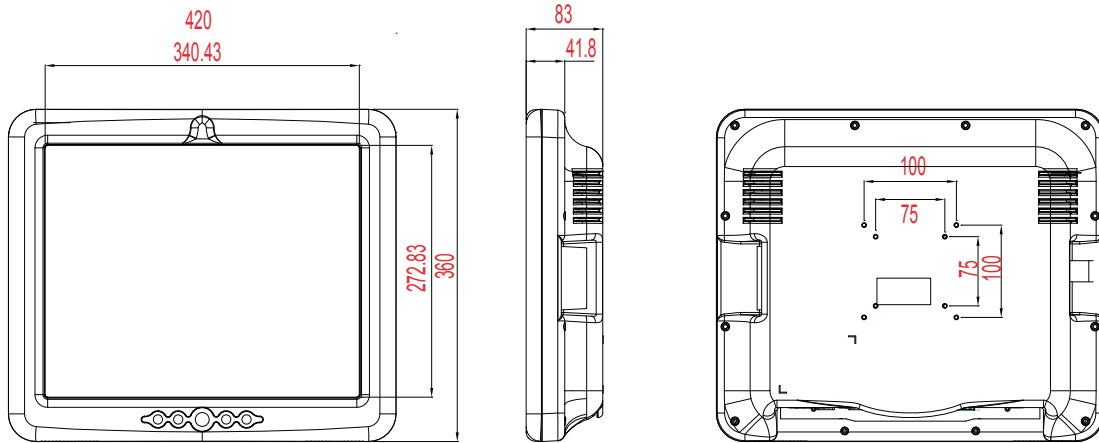

### Packaging / Options / Customization

- Packaging** System, power adaptor, AC power cord, CD (drivers & manual)
- Options**
- WLAN – 802.11 b/g/n mini PCIe module w/ internal antenna x 2
  - Bluetooth 2.1 (USB)
  - Power adaptor w/ 2.4m or 3.6m DC cable
  - Anti-bacteria desktop stand (metal, white)
  - Change touch to glass



### I/O Connectors

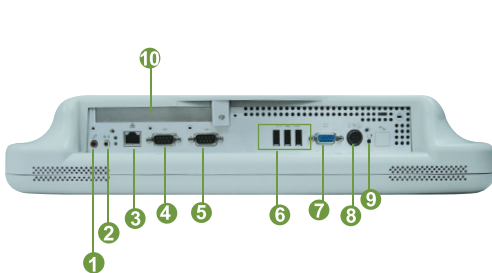

- ① Microphone-in
- ② Line-out
- ③ Giga LAN
- ④ RS232/422/485
- ⑤ RS232
- ⑥ USB x 3
- ⑦ VGA
- ⑧ DC-in
- ⑨ Reset
- ⑩ PCI/E expansion

### Ordering Information

- Memory: 1G / 2G / 4G
- HDD: 160G / 500G
- I/O cover: None / x 1
- WLAN: None / x 1
- Power adaptor: 1.2m / 2.4m / 3.6m DC cable
- Bluetooth: None / x 1
- Desktop stand: None / x 1
- Touch: Yes / Change to glass



Web: [www.wincomm.com.tw](http://www.wincomm.com.tw)

Contact: [sales\\_support@wincomm.com.tw](mailto:sales_support@wincomm.com.tw)

#### Wincomm Corporation

3F, NO. 14, Prosperity Road II, Science-Based Industrial Park,  
Hsinchu, Taiwan 30078, R.O.C

Tel : +886 3 578 0000 Fax: +886 3 578 0295