

DA-1000

Intel® Atom™ or Celeron® Processor Affordable Fanless Embedded Computer



- Onboard Intel® Atom™ or Celeron® Processors
- One DDR3L SO-DIMM Socket, Support Up to 8G
- Support Dual Display, Output from One DVI-I Port
- Dual Intel® I210 GbE LAN Ports, Support WoL, Teaming, PXE
- Ultra Compact Size (150x105x56.02mm)
- Support -25°C~70°C Extended Operating Temperature
- Support 9~48VDC Input, Support AT/ATX Power Mode
- CMI (Combined Multiple I/O) Interface for I/O Module Expandability
- Various Mounting Options (VESA, DIN-Rail, Side/Wall Mounting)

Overview

DA-1000 Series is an ultra-compact size fanless embedded computer powered by Intel® Atom™ or Celeron® Processors; it integrated HD graphics processor supporting dual display. This can bring economic advantages on budget and also fulfill the needs for industrial computing tasks. DA-1000 Series manages to pack a diverse array of I/O into its small form factor, with one DVI-I port, two RS-232/422/485 COM ports, dual Gbe LAN ports, four USB ports and one set of Mic-in and Line-out.

DA-1000 Series supports Combined Multiple I/O (CMI) interface and modules which are especially designed for flexible I/O expandability; it allows users to extend various I/Os according to their needs. CMI modules are including COMs, DIO, DisplayPort, DVI, LPT/PS2 or VGA. The rugged construction, wide operating temperature and high tolerance for shock and vibration enables DA-1000 Series to deploy in a harsh environment and for critical applications, and it is totally maintenance-free.

Highlights

Ultra Compact

- Palm-size volume in only 150 x 105 x 56.02 mm
- All in one system with comprehensive I/O Interfaces and flexible expansions

Highly Modularized

- CMI interface and modules offers the possibilities to extend I/O in a small footprint construction
- MEC Modules and dedicated I/O brackets are available

Rugged & Reliable

- Wide temperature range (-25°C~70°C) for operating in harsh environment
- Shock (50 Grms) and vibration (5 Grms) resistance
- OCP, OVP and ESD protections

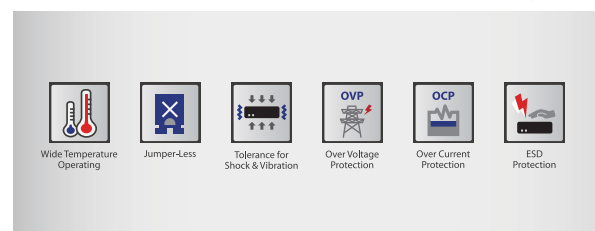

Specifications

Processor

- Intel® Atom™ Processor E3826 (1M Cache, Up to 1.46 GHz SoC, 7W TDP)
- Intel® Atom™ Processor E3845 (2M Cache, Up to 1.91 GHz SoC, 10W TDP)
- Intel® Celeron® Processor J1900 (2M Cache, Up to 2.42 GHz SoC, 10W TDP)

BIOS

- AMI 64 Mbit SPI BIOS

Memory

- 1x DDR3L 204-pin SO-DIMM, support up to 8GB (1066/1333MHz, un-buffered and non-ECC type)

Graphics

- Integrated Intel® HD Graphics
- Two Independent Display

Audio

- Realtek® ALC888S
- High Definition Audio

I/O Interface

- 1x DVI-I Connector, Up to 1920 x 1080
- 2x GbE LAN Ports (Support Wake On Lan, Teaming, Jumbo Frame, PXE), RJ45
 - GbE1: Intel® I210
 - GbE2: Intel® I210
- 2x RS-232/422/485 with Auto Flow Control, DB9
- 1x USB 3.0 & 3x USB 2.0 (Type-A)
- 1x Mic-in and 1x Line-out, Phone Jack 3.5mm
- 1x ATX Power On/Off Switch Button
- 1x AT/ATX Mode Switch
- 1x Remote Power On/Off Connector, 2-Pin Terminal Block

Storage

- 1x mSATA (SATA 2.0, Shared by Mini-PCIe Socket)
- 1x 2.5" SATA HDD Bay (Optional 1x Half-Slim SSD, SATA 2.0)

Expansion

- 1x CMI Interface for CMI Modules
- 2x Full-size Mini-PCIe (Supports Wireless & I/O Expansion)
- 1x SIM Socket
- 1x Universal I/O Bracket
- 2x Antenna Holes

Other Function

- Instant Reboot Technology (0.2 sec)
- Watchdog Timer:
 - Software Programmable Supports 256 Levels System Reset

Power Requirement

- Support AT/ATX Power Type
- Power Input Voltage 9~48VDC
- 3-Pin Terminal Block Connector
- Optional Power Adapter AC/DC 12V/5A 60W

Physical

- Dimension (WxDxH): 150 x 105 x 52.3 mm
- Weight: 0.86kg
- Construction: Extruded Aluminum with Heavy Duty Metal
- Mounting: VESA / Wall Mounting (Optional DIN-Rail / Side Mounting)
- Unibody Design
- Fanless Design
- Jumper-less Design

Protection

- Reverse Power Input Protection Supported
- Over Voltage Protection (OVP)
 - Protection Range: 51~58V
 - Protection Type: shut down operating voltage, re-power on at the preset level to recover
- Over Current Protection (OCP) 120V/ 20A
- ESD Protection Air Discharge: +/-8kV (air), +/-4kV (contact)

Operating System

- Windows® 10
- Windows® 8.1
- Windows® 7

Environment

- Operating Temperature: -25°C to 70°C (With extended temperature peripherals; Ambient with Air Flow by IEC60068-2-1, IEC60068-2-2, IEC60068-2-14)
- Storage Temperature: -40°C to 85°C
- Relative Humidity: 95% RH @ 40°C (Non-condensing)
- Shock: 50 Grms (With SSD According to IEC 60068-2-27, Half Sine, 11ms Duration)
- Vibration: Random: 5 Grms (With SSD According to IEC 60068-2-64, 5~500Hz, 1 hr/axis)

Certification

- EMC: CE, FCC Class A
- Safety: CB 62368-1, IEC/EN 62368-1

External Layout

Front I/O

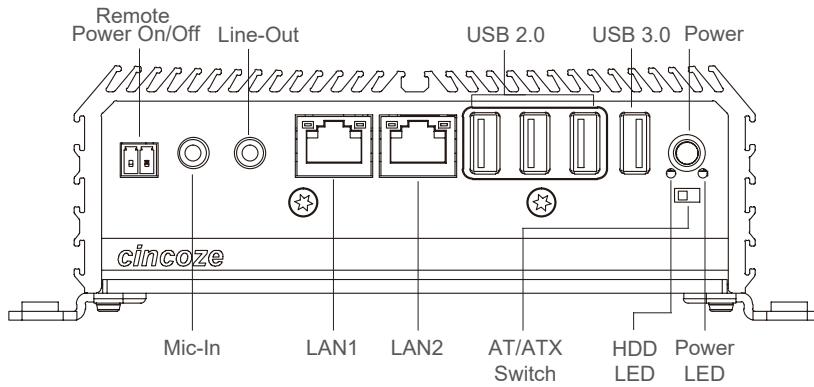

Rear I/O

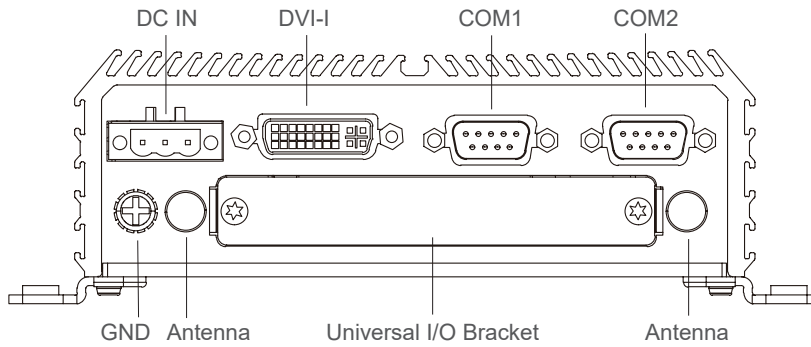

Dimensions

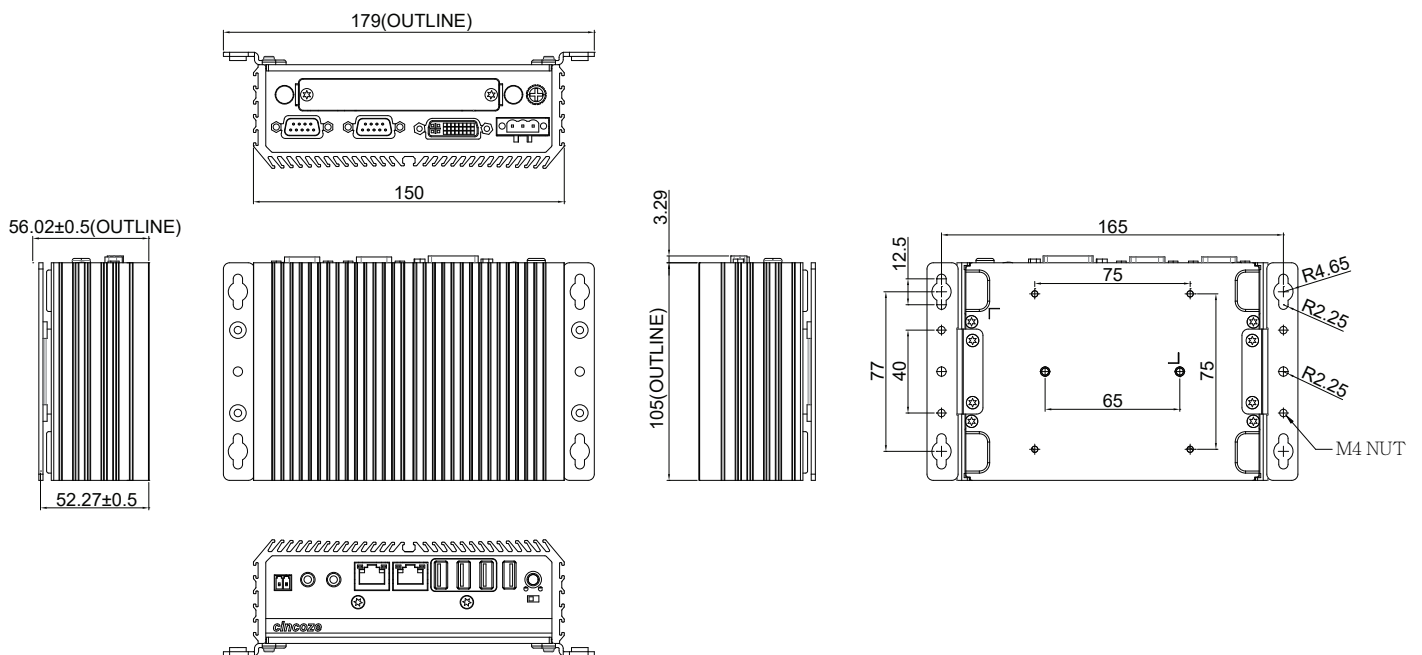

Ordering Information

Available Models







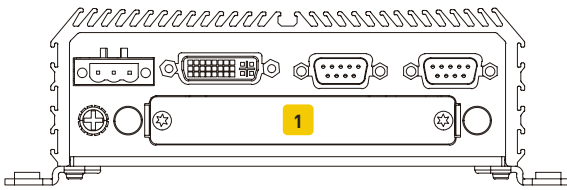

Model No.	Description
DA-1000-R10	Intel® Atom™ E3826 Affordable Fanless Embedded Computer
DA-1000-E45-R10	Intel® Atom™ E3845 Affordable Fanless Embedded Computer
DA-1000-J19-R10	Intel® Celeron® J1900 Affordable Fanless Embedded Computer

Package Checklist

• DA-1000 Embedded System x 1	• Utility DVD Driver x 1
• Power Terminal Block Connector x 1	• DVI-I to VGA Adapter x 1
• Remote Power On/Off Terminal Block Connector x 1	• Screw Pack x 1 (For HDD/Mini-PCIe/Wall & VESA Mounting)
	• Wall Mount Kit x 1

Optional I/O Modules

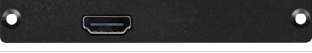

Model No.	Description	1
 CMI-COM102/UB0403	CMI Module with 2x RS232/422/485, 1x Universal Bracket (96 x 15 mm)	V
 CMI-DIO100/UB0415	CMI Module with 8x Optical Isolated DIO (4 in/4 out), 1x Universal Bracket (96 x 15 mm)	V
 CMI-DP101/UB0406	CMI Module with 1x Display Port, 1x Universal Bracket (96 x 15 mm)	V
 CMI-DVI101/UB0407	CMI Module with 1x DVI-D Connector, 1x Universal Bracket (96 x 15 mm)	V
 CMI-LPPS102/UB0409	CMI Module with 1x LPT Port, 1x PS/2, 1x Universal Bracket (96 x 15 mm)	V
 CMI-VGA101/UB0416	CMI Module with 1x VGA Port, 1x Universal Bracket (96 x 15 mm)	V
 CMI-HD01/UB0408	CMI Module with 1x HDMI Port for DA Series, 1x Universal Bracket with HDMI Cutout for DA Series	V
 MEC-LAN-M102-15/UB0411	Mini-PCIe Module with 2x LAN Ports, 1x Universal Bracket (96 x 15 mm) * Only can be compatible with half slim SSD and mSATA when MEC-LAN is installed.	V
 MEC-USB-M102-15/UB0414	Mini-PCIe Module with 2x USB 3.0 Ports, 1x Universal Bracket (96 x 15 mm) * Only can be compatible with half slim SSD and mSATA when MEC-USB is installed.	V

Optional Accessories

Model No.	Description
SIDE02	Side Mount Kit for DA Series, with KMRH-K175 for DIN-Rail option
DINRAIL-R10	Diamond series DIN-RAIL Mount Kit
HBK01	DA-1000 Half-Slim SSD Bracket with 6x Screws
GST60A12-CIN1	Adapter AC/DC 12V 5A 60W, with 3pin Terminal Block Plug 5.0mm Pitch with Tubes, Level VI