

EC510/EC511-CS

8th/9th Gen Intel® Core™
Modular-Designed Embedded System



KEY FEATURES



DDR4

DDR4 SODIMM up to 64GB



PoE

Support 4 PoE (EC51x-CS6G86E-Q)



Three Independent Displays

1 VGA + 2 HDMI/DP++ (auto detection)
(for EC51x-CS6G86E and EC51x-CS6G86 SKU)



Support 5G Communication

Support 5G communication

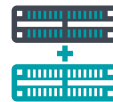

Multiple Expansion

1 PCIe and 3 M.2 slots support NVMe



Wide-Temperature

Operating Temperature: -20 to 70°C

PANEL

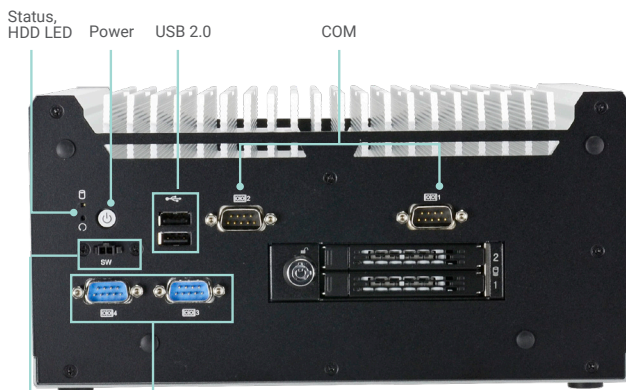

Front View

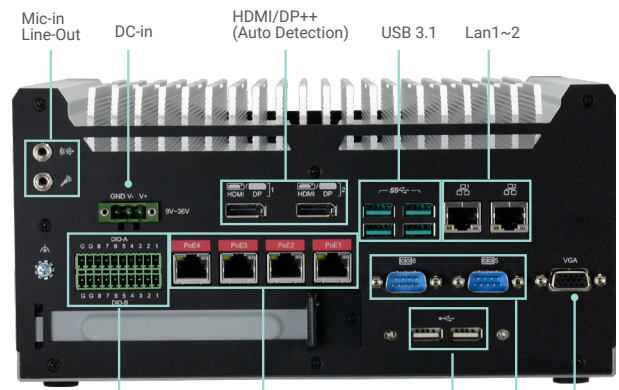

Rear View

DIMENSIONS

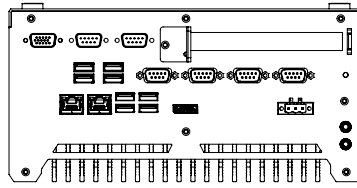

Front View

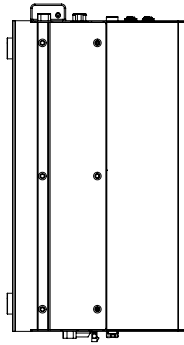

Left View

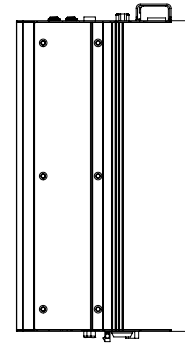
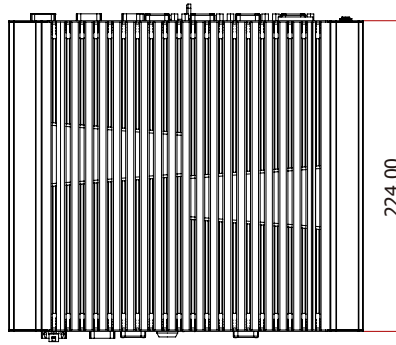

Right View

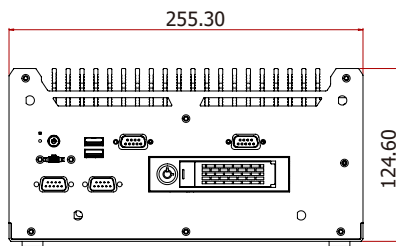

Rear View

WALL MOUNTING

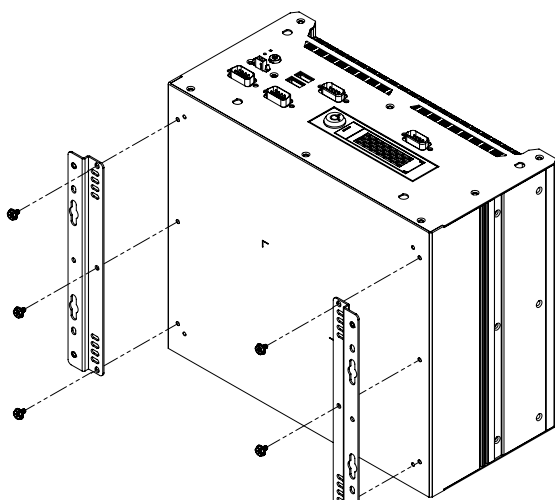

531-510300-000G
A31-028003-102G

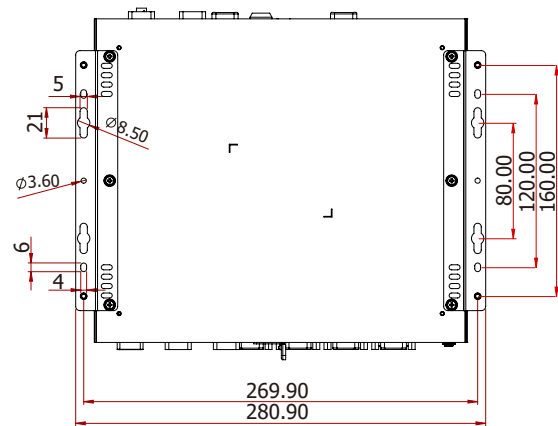

SPECIFICATION

SYSTEM	Processor	8th/9th Generation Intel® Core™ Processors, LGA 1151 Intel® Core™ i7-9700TE , Octa Cores, 12M Cache, up to 3.8 GHz, 35W Intel® Core™ i5-9500TE , Hexa Cores, 9M Cache, up to 3.6 GHz), 35W Intel® Core™ i3-9100TE, Quad Cores, 6M Cache, up to 3.2 GHz, 35W Intel® Core™ i7-8700T Processor, Hexa Core, 12M Cache, 2.4GHz (4GHz), 35W Intel® Core™ i5-8500T Processor, Hexa Core, 9M Cache, 2.1GHz (3.5GHz), 35W Intel® Core™ i3-8100T Processor, Quad Core, 6M Cache, 3.1GHz, 35W Intel® Pentium® Processor G5400T, Dual Core, 4M Cache, 3.1GHz, 35W Intel® Celeron® Processor G4900T, Dual Core, 2M Cache, 3.1GHz, 35W	
	Chipset	Intel® Q370/H310 Chipset	
	Memory	Two 260-pin DDR4 2400/2666MHz SODIMM up to 64GB	
	BIOS	AMI SPI 128Mbit	
	GRAPHICS	Controller	Intel® HD Graphics
Feature		OpenGL up to 5.0, DirectX 11, OpenCL 2.1 HW Decode: HEVC/H.265, H.264, M/JPEG, MPEG2, VC1/WMV9, VP8 (8-bit), VP9 (10-bit) HW Encode: HEVC/H.265, M/JPEG, MPEG2, VP8	
Display		-EC51x-CS6G86E-Q/EC51x-CS6G86-Q 1 x VGA 2 x HDMI/DP++ (auto detection) -EC51x-CS98A1-H 1 x VGA 1 x HDMI/DP++ (auto detection)	VGA: resolution up to 1920x1200 @ 60Hz HDMI: resolution up to 4096x2160 @ 30Hz DP++: resolution up to 4096x2304 @ 60Hz
Double/Triple Displays		-EC51x-CS6G86E-Q/EC51x-CS6G86-Q VGA + 2 x HDMI/DP++ (auto detection) -EC51x-CS98A1-H VGA + 1 x HDMI/DP++ (auto detection)	
STORAGE	Interface	2 x 2.5" SATA 3.0 drive bay support RAID 0/1 (EC51x-CS6G86E-Q/EC51x-CS6G86-Q)	
EXPANSION	Interface	-EC510-CS6G86E-Q/EC510-CS6G86-Q 1 x M.2 2230 E key (PCIe/USB 2.0) 1 x M.2 2280 M key (PCIe x4 NVMe/SATA) 1 x M.2 3042/3052 B key (PCIe/USB 3.0) 1 x PCI slot -EC510-CS98A1-H 1 x M.2 2230 E key (PCIe/USB 2.0) 1 x M.2 2280 M key (SATA) 1 x M.2 3042/3052 B key (PCIe) 1 x PCI slot -EC511-CS6G86E-Q/EC511-CS6G86-Q 1 x M.2 2230 E key (PCIe/USB 2.0) 1 x M.2 2280 M key (PCIe x4 NVMe/SATA) 1 x M.2 3042/3052 B key (PCIe/USB 3.0) 1 x PCIe x16 slot -EC511-CS98A1-H 1 x M.2 2230 E key (PCIe/USB 2.0) 1 x M.2 2280 M key (SATA) 1 x M.2 3042/3052 B key (PCIe) 1 x PCIe x16 slot	
		Audio Codec	ALC888
AUDIO	Controller	-EC51x-CS6G86E-Q/EC51x-CS6G86-Q 1 x Intel® I210AT PCIe (10/100/1000Mbps) 1 x Intel® I219LM with iAMT11.0 PCIe (10/100/1000Mbps) (only Core i7/i5 supports iAMT) -EC51x-CS98A1-H 1 x Intel® I210AT PCIe (10/100/1000Mbps) 1 x Intel® I219V with iAMT11.0 PCIe (10/100/1000Mbps) (only Core i7/i5 supports iAMT)	
ETHERNET	Indicators	1 x Status LED 1 x HDD LED	
LED	Serial	4 x RS-232/422/485 (DB-9)	
	USB	2 x USB 2.0 (type A)	
	Buttons	1 x Power button 1 x Reset button	
	Antenna	4 x Antenna hole (WiFi)	
FRONT I/O			

SPECIFICATION

REAR I/O	Ethernet/PoE	-EC51x-CS6G86E-Q 2 x GbE (RJ-45) 4 x PoE (RJ-45) -EC51x-CS6G86-Q 6 x GbE (RJ-45) -EC51x-CS98A1-H 2 x GbE (RJ-45)	
	COM	-EC51x-CS6G86E-Q/EC51x-CS6G86-Q 2 x RS232 -EC51x-CS98A1-H 3 x RS232/422/485 2 x RS232	
	USB	-EC51x-CS6G86E-Q/EC51x-CS6G86-Q 4 x USB 3.1(Gen.2) 2 x USB2.0 -EC51x-CS98A1-H 4 x USB 3.1(Gen.2) 4 x USB 3.1(Gen.1)	
	DIO	-EC51x-CS6G86E-Q/EC51x-CS6G86-Q 16 bits DIO -EC51x-CS98A1-H 8 bits DIO	
	Display	-EC51x-CS6G86E-Q/EC51x-CS6G86-Q VGA + 2 x HDMI/DP++ (auto detection) -EC51x-CS6G86E-Q/EC51x-CS6G86-Q VGA + 1 x HDMI/DP++ (auto detection)	
	Audio	1 x Line-out 1 x Mic-in	
	WATCHDOG TIMER	Output & Interval	System reset, programmable via software from 1 to 255 seconds
	SECURITY	TPM	TPM 2.0
POWER	Type	Wide range 9~36V	
	Connector	3-pole terminal block 2-pin power extension switch connector	
OS SUPPORT	OS Support	Windows 10 IoT Enterprise 64 Bit Linux (available upon request)	
ENVIRONMENT	Operating Temperature	-20 to 70°C (2.5" SSD or M.2 SSD)	
	Storage Temperature	-20 to 85°C	
	Relative Humidity	5 to 95% RH (non-condensing)	
MECHANICAL	Construction	Metal + Aluminum	
	Mounting	Wall mount	
	Dimensions (W x H x D)	255.3 x 124.6 x 224mm	
	Weight	5.1 kg	
STANDARDS AND CERTIFICATIONS	Shock	Half sine wave 3G, 11ms, 3 shock per axis	
	Vibration	IEC68-2-64	
	Certifications	CE, FCC Class A	

ORDERING INFORMATION

Model Name	Part Number	Description
EC510-CS	750-EC5102-000G	EC510-CS6G86E-Q:Fanless, CS263,Q370, 6 COM, 16 DIO, 6 USB, 2 HDMI/DP, 1 VGA, 2 LAN, 1 Line-out, 1 Mic-in, 4 POE (802.3af), 1 PCI, DC 9~36V input, TPM2.0, F/G SYSTEM RoHS
EC510-CS	750-EC5102-100G	EC510-CS6G86-Q:Fanless, CS263,Q370, 6 COM, 16 DIO, 6 USB, 2 HDMI/DP, 1 VGA, 6 LAN, 1 Line-out, 1 Mic-in, 1 PCI, DC 9~36V input, TPM2.0, F/G SYSTEM RoHS
EC510-CS	750-EC5102-200G	EC510-CS98A1-H:Fanless, CS263,H310, 9 COM, 16 DIO, 10 USB, 1 HDMI/DP, 1 VGA, 2 LAN, 1 Line-out, 1 Mic-in, 1 PCI, DC 9~36V input, TPM2.0, F/G SYSTEM RoHS
EC511-CS	750-EC5113-000G	EC511-CS6G86E-Q:Fanless, CS263,Q370, 6 COM, 16 DIO, 6 USB, 2 HDMI/DP, 1 VGA, 2 LAN, 1 Line-out, 1 Mic-in, 4 POE (802.3af), 1 PCIe x16, DC 9~36V input, TPM2.0, F/G SYSTEM RoHS
EC511-CS	750-EC5113-100G	EC511-CS6G86-Q:Fanless, CS263,Q370, 6 COM, 16 DIO, 6 USB, 2 HDMI/DP, 1 VGA, 6 LAN, 1 Line-out, 1 Mic-in, 1 PCIe x16, DC 9~36V input, TPM2.0, F/G SYSTEM RoHS
EC511-CS	750-EC5113-200G	EC511-CS98A1-H:Fanless, CS263,H310, 9 COM, 16 DIO, 10 USB, 1 HDMI/DP, 1 VGA, 2 LAN, 1 Line-out, 1 Mic-in, 1 PCIe x16, DC 9~36V input, TPM2.0, F/G SYSTEM RoHS

PACKING LIST

1 EC510/EC511-CS system unit
1 M.2 slot screws
1 terminal block 3-pole for DC input
1 cable with 2 wire stripped and tinned to DC jack