

# RC300-CS

C246  
Q370



8th/9th Gen Intel® Core™  
AI-Enabled Railway Embedded System



## KEY FEATURES



### High Performance CPU

Intel® Coffee Lake Xeon/Core i7 processor



### M12 Type POE

4 x M12 type PoE ports at 15W



### AI Accelerated

Up to 110W GPU MXM module supported

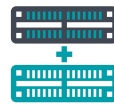

### Scalability

Multiple expansion slots for 3G/LTE/5G cellular support



### Support 5G Communication

Support 5G communication



### Wide-Temperature

-25°C to 70°C operation without active fan



## PANEL

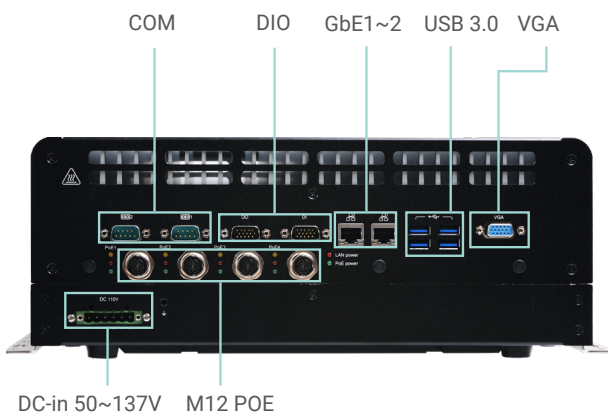

Front View

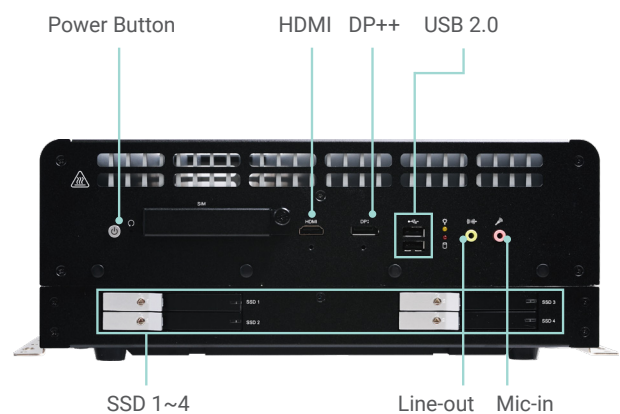

Rear View

## DIMENSIONS

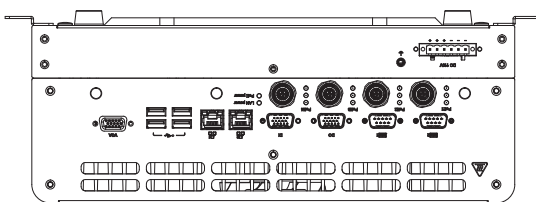

Front View

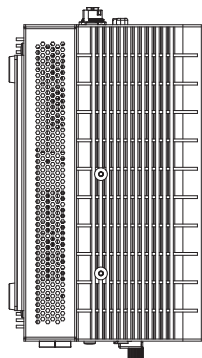

Left View

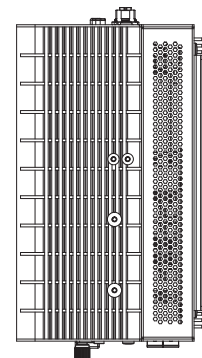
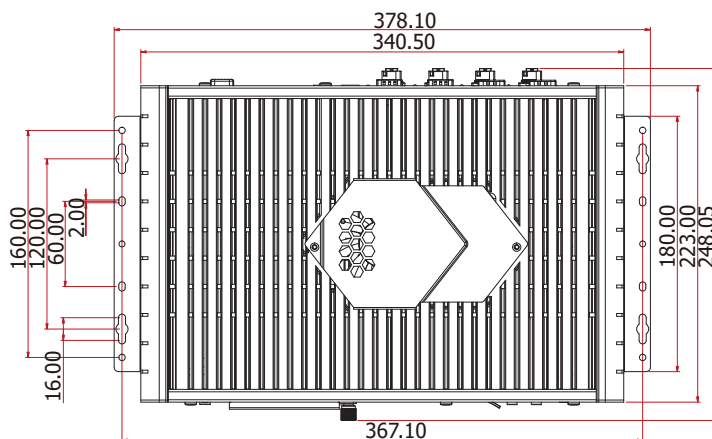

Right View

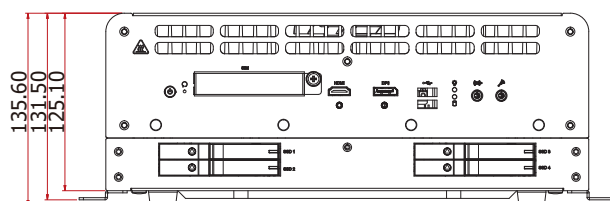

Rear View

## WALL MOUNTING

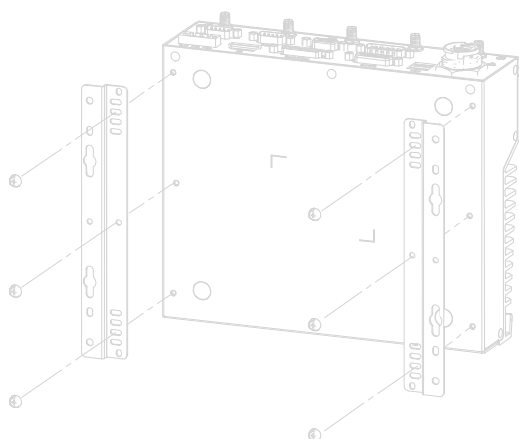

COMING SOON

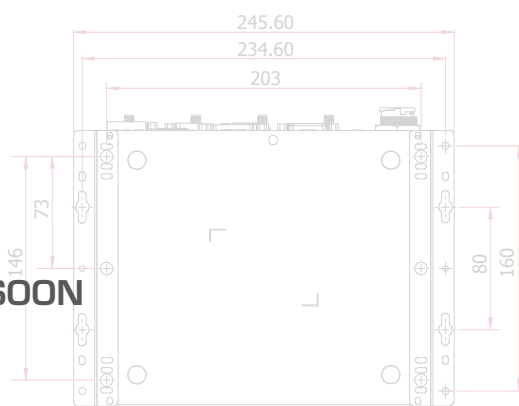

## SPECIFICATION

SYSTEM	Processor	8th/9th Generation Intel® Core™ Processors, LGA 1151 Intel® Xeon® Processor E-2278GEL 8C/16CT, 16MB Cache, 2.0GHz, TDP 35W Intel® Core™ i7-9700TE Processor, 8C/8T, 12MB Cache, 1.8GHz, TDP 35W Intel® Core™ i7-8700T Processor, 6C/12T, 12MB Cache, 2.4GHz, TDP 35W Intel® Core™ i5-9500TE Processor, 6C/6T, 9MB Cache, 2.2GHz, TDP 35W Intel® Core™ i3-9100TE Processor, 4C/4T, 6MB Cache, 2.2GHz, TDP 35W
	Chipset	Intel® C246/Q370 Chipset
	Memory	Dual Channel DDR4 2666/2400 MHz by SODIMMs up to 64GB
	BIOS	Insyde SPI 128Mbit
GRAPHICS	Controller	Intel® HD Graphics
	GPU	Support MXM 3.1 Type A & B: T3000, GTX 1050ti, GTX1060, GTX1070 GPU modules Maximum Package power 120W, inrush current 150W PCIe x16
	Display	1 x VGA (display out by DB15 connector)      VGA: resolution up to 1920x1200 @ 60Hz 1 x HDMI (with screw lock)                      HDMI: resolution up to 4096x2160 @ 24Hz 1 x DP++ (Standard Display Port Connector DIP type with screw lock) support NVIDIA Optimus technology      DP++: resolution up to 4096x2304 @ 60Hz
STORAGE	External	4 x Swappable 2.5" Storage Bay with Lock. Supports 7mm SSD devices
EXPANSION	Interface	1 x Half-size Mini PCIe for WiFi/BT Modules, with PCIe x1 & USB signal 2 x Full-size Mini PCIe support PCIe x1 & USB 2.0 signal with SIM of each (All SIM Cards can be external accessible with cover against vibration) 1 x M.2 B key support PCIe x1, USB2.0, USB3.0 signal with SIM slot (SIM card can be external accessible with cover) 1 x M.2 2280 M key supports 2242, 2260 & 2280 devices (PCIe x4 & SATA signal, support boot up function)
ETHERNET	Controller	5 x Intel® I210IT NIC (10/100/1000Mbps) 1 x Intel® I219LM PHY (10/100/1000Mbps)
	Interface	2 x RJ45 GbE 4 x M12 802.3af 15W PoE ports
LED	Indicators	1 x Power LED (Green) 5 x Storage LED (Red) 4 x POE LED
FRONT I/O	Ethernet	2 x GbE (RJ-45) support Wake on Lan
	Serial	2 x BIOS selection RS-232/422/485 by 2x DB-9
	DIO	1x 8bit isolated DI port by DB-15 connector 1x 8bit isolated DO port by DB-15 connector 2KV isolation
	Display	1 x VGA display out by DB15 connector
	USB	4 x USB 3.0 (type A)
	Power-in	1 x 6Pins 5.0mm Terminal Block
	POE	4 x M12 802.3af POE by XCT7-4POEM12 with LEDs Support 802.11af, max 15.4W (PSE side) NOT support wake on Lan
REAR I/O	USB	2 x USB 2.0 (type A)
	Display	1 x HDMI 1 x DP++
	Audio	1 x Mic-in 1 x Line-out by 3.5mm 3P Phone Jack
	Buttons	1 x Power Button 1 x Reset Button
	SIM	3 x SIM sockets (external accessible with cover)
WATCHDOG TIMER	Output & Interval	System Reset, Programmable via Software from 1 to 255 Seconds
SECURITY	TPM	TPM 2.0
POWER	Type	72/96/110VDC nominal power input 50.4VDC~137.5VDC power range
	Connector	6 pin 5.0mm Terminal Block
OS SUPPORT	OS Support	Windows 10 IoT Enterprise 64 Bit Ubuntu 18.04
MECHANISM	Construction	Metal + Aluminum
	Mounting	Wall Mount
	Dimensions (W x H x D)	340.5(W) x 223(D) x 132(H) mm (3U height, excluding rubber foot)
	Weight	9.85 kg

## SPECIFICATION

<b>ENVIRONMENT</b>	<b>Operating Temperature</b>	-25°C to 70°C with when CPU+GPU<100W, up to +85°C for 10min -25°C to 55°C with when CPU+GPU<160W, up to +70°C for 10min CPU throttling at high temperature is acceptable
	<b>Storage Temperature</b>	-40 to 85°C
	<b>Relative Humidity</b>	10% to 90% (non-condensing)
<b>STANDARDS AND CERTIFICATIONS</b>	<b>Shock (SSD/HDD)</b>	EN61373: 2010, Category 1 Class A & Class B
	<b>Vibration</b>	EN61373: 2010, Category 1 Class B
	<b>IP rating</b>	IP40
	<b>Certification</b>	CE, FCC Class B (Tested with Adapter) EMC: EN50121-3-2 Safety: EN50153, EN50124-1 Fire Proof: EN45545 Railway Regulation: EN50155 (Class S2: 10ms interruptions) (Supply Change Over Class C1: at 0,6 Un during 100ms without interruptions)

## ORDERING INFORMATION

Model Name	Part Number	Description
RC300-CS2G66-QM12	750-RC3000-000G	RC300-CS2G66-QM12 : Fanless Railway System, CST51-Q370T, 8 4 M12 PoE, 2 COM, 6 USB, 2 LAN, 16 DIO, DC110V, F/G, RoHS

## OPTIONAL ITEMS

Optional Items	Part Number	Description
CPU	143-10240A-500G	CPU Intel Core i7-8700T 2.4GHz C/12M,U0,CM8068403358413 SR3WX/FCLGA-1151(INTEL) RoHS
	143-103205-500G	CPU Intel Core i7-8700 3.2GHz C/12M,U0,CM8068403358316 SR3QS/FCLGA-1151(INTEL) RoHS
	143-102104-501G	CPU Intel Core i5-8500T 2.1GHz C/9M,U0,CM8068403362509 SR3XD/FCLGA-1151(INTEL) RoHS
	143-10300A-500G	CPU Intel Core i5-8500 3.0GHz,C/9M,U0,CM8068403362607 SR3XE/FCLGA-1151(INTEL) RoHS
	143-103105-500G	SCPU Intel Core i3-8100T 3.1GHz C/6M CM8068403377415 SR3Y8/FCLGA-1151(INTEL)RoHS
	143-103602-500G	CPU Intel Core i3-8100 3.6GHz C/6M B0 CM8068403377308 SR3N5/FCLGA-1151(INTEL) RoHS
	TBD	Intel Xeon E-2124G
	TBD	Intel Xeon E-2176G
Memory	TBD	4GB DDR4 SODIMM RAM -40~85°C
	TBD	8GB DDR4 SODIMM RAM -40~85°C
	TBD	16GB DDR4 SODIMM RAM -40~85°C
M.2 SSD	638-703216-100G	Flash Module M.2 2280 SATAIII 32GB MLC 3ME4 DEM28-32GM41BC1DC (INNODISK), RoHS
	638-703213-110G	Flash Module M.2 2242 SATAIII 32GB MLC 3ME4 -40~85°C DEM24-32GM41BW1DC (INNODISK), RoHS
2.5" HDD/SSD	635-550092-050G	2.5" SATA HDD, 500GB, RoHS
	635-500100-200G	2.5" SATA HDD, 1TB, RoHS
	635-605122-160G	SSD 2.5" SATAIII 512GB MLC 3ME3 -40~85°C DES25-C12D08BW1QC (INNODISK)RoHS
	635-610002-140G	SSD 2.5" SATAIII 512GB MLC 3ME3 -40~85°C DES25-C12D08BW1QC (INNODISK)RoHS
mSATA	638-706407-120G	mSATA Card, 128GB MLC, RoHS (Wide temperature)
	638-706407-130G	mSATA Card, 64GB MLC, RoHS (Wide temperature)
Wi-Fi	761-AP1235-000G	Wi-Fi Kit, SparKLAN, WPEA-121N, w/IPX cable & antenna
	612-AP1235-100G	Mini-PCIe WiFi+BT Module 802.11a/b/g/n/ac + Bluetooth 4.1,-40~85°C,AP12356_I(AMPAK) RoHS
4G/LTE+GPS	761-110040-000G	4G Module, W/Antenna*3, SMA Cable*3, Quectel EC20-E-MINIPICIE-S RoHS
	612-EG25GG-000G	Mini PCIe LTE Cat4 Module, 51x30x4.9mm, EG25GGB-MINIPICIE-S (QUECTEL) RoHS
Power Cord	785-PWRD	Power Cord, Standards (USA/EUR/CH), 1.8m, RoHS for test only
Power Adapter	TBD	Power Adapter 350W , 48V/7.3A for test only
Wall Mount	761-EC5410-000G	ACCESSORY WALL MOUNT KITS EC5-Series RoHS

## PACKING LIST

1 RC300-CS system unit
1 Power connector
1 Mounting Bracket