

EC532-KD-AI

H110



Features

- Supports DDR4 SODIMM up to 32GB
- Two independent displays: 1 VGA + 1 DVI/HDMI
- Front accessible storage slots
- Rich I/O connectivity
- 3 expansion slots: PCIe x16 + PCIe x4 (PCIe x1 signal)

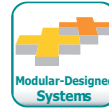

Panel

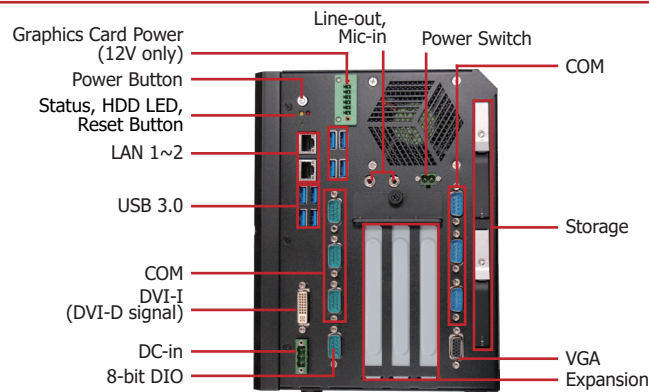

Rear View
EC532-KD-AI6881

Dimensions

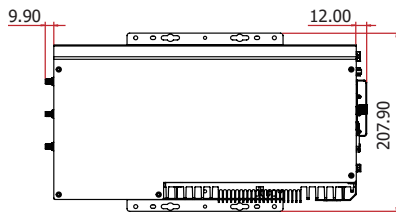

Front View

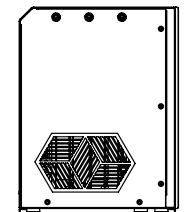

Left View

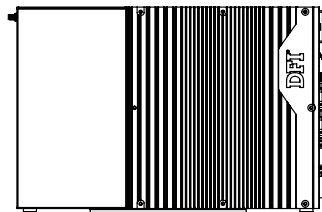

Top View

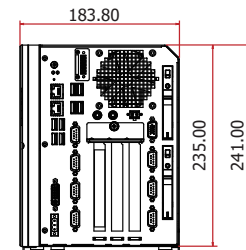

Right View

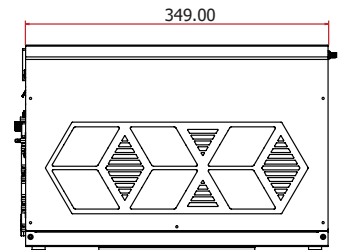

Bottom View

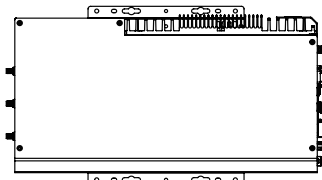

Rear View

► Specifications

SYSTEM	Processor	6th/7th Generation Intel® Core™ Processors, LGA 1151 Socket Intel® Core™ i7-6700TE, Quad Core, 8M Cache, 2.4GHz (3.4GHz), 35W Intel® Core™ i5-6500TE, Quad Core, 6M Cache, 2.3GHz (3.3GHz), 35W Intel® Core™ i3-6100TE, Dual Core, 4M Cache, 2.7GHz, 35W Intel® Core™ i7-7700T, Quad Core, 8M Cache, 2.9GHz (3.8GHz), 35W Intel® Core™ i5-7500T, Quad Core, 6M Cache, 2.7GHz (3.5GHz), 35W Intel® Core™ i3-7101TE, Dual Core, 3M Cache, 3.4GHz, 35W	
	Chipset	Intel® H110 Chipset	
	Memory	Two 260-pin SODIMM up to 32GB	Dual Channel DDR4 1866/2133MHz
	BIOS	Insyde SPI 128Mbit	
GRAPHICS	Controller	Intel® HD Gen 9 Graphics	
	Feature	OpenGL 5.0, DirectX 12, OpenCL 2.1 HW Decode: AVC/H.264, MPEG2, VC1/WMV9, JPEG/MJPEG, HEVC/H265, VP8, VP9 HW Encode: MPEG2, AVC/H264, JPEG, HEVC/H265, VP8, VP9	
	Display	1 x VGA 1 x DVI-I (DVI-D signal)/HDMI (HDMI available upon request)	VGA: resolution up to 1920x1200 @ 60Hz DVI: resolution up to 1920x1200 @ 60Hz
	Dual Displays	VGA + DVI (DVI-D signal) (Default) VGA + HDMI (available upon request)	
STORAGE	External	2 x 2.5" SATA 3.0 Drive Bay (Removable, support thickness 7mm HDD or SSD) (RAID 0/1)	
EXPANSION	Interface	1 x PCIe x16 (PCIe x16 signal) + 1 x PCIe x4 (PCIe x1 signal) 1 x Full-size Mini PCIe (PCIe/USB2.0) 1 x Half-size Mini PCIe (USB2.0/mSATA)	
	Controller	1 x Intel® I211AT PCIe (10/100/1000Mbps) 1 x Intel® I219LM with iAMT11.0 PCIe (10/100/1000Mbps) (only Core i7/i5 supports iAMT)	
ETHERNET	Controller	1 x Intel® I211AT PCIe (10/100/1000Mbps) 1 x Intel® I219LM with iAMT11.0 PCIe (10/100/1000Mbps) (only Core i7/i5 supports iAMT)	
LED	Indicators	1 x Status LED 1 x HDD LED	
REAR I/O	Ethernet	2 x GbE (RJ-45)	
	Serial	4 x RS-232/422/485 (DB-9) (RS-232 with power) 2 x RS-232/422/485 (DB-9)	
	USB	8 x USB 3.0 (type A)	
	Display	1 x VGA 1 x DVI-I (DVI-D signal)/(HDMI available upon request)	
	Audio	1 x Line-out 1 x Mic-in	
	DIO	1 x 8-bit DIO	
	Buttons	1 x Power Button 1 x Reset Button	
	Antenna Hole	3 x Antenna Hole	
WATCHDOG TIMER	Output & Interval	System Reset, Programmable via Software from 1 to 255 Seconds	
SECURITY	TPM	TPM 1.2 (optional)	
POWER	Type	Wide Range 9~36V	
	Connector	3-pole Terminal Block	
OS SUPPORT		Windows 7 (32/64-bit) Windows 10	Windows 8.1 (64-bit)
MECHANISM	Construction	Aluminum + Sheet Metal	
	Mounting	Wall Mount	
	Dimensions (W x H x D)	235mm x 102.5mm x 222mm (W x H x D)	
	Weight	TBD	
ENVIRONMENT	Operating Temperature	0 to 45°C (HDD, with 0.7m/s air flow) -20 to 50°C (SSD or mSATA-mini, with 0.7m/s air flow)	
	Storage Temperature	-20 to 85°C	
	Relative Humidity	5 to 90% RH (non-condensing)	
STANDARDS AND CERTIFICATIONS	Shock	Half sine wave 3G, 11ms, 3 shock per axis	
	Vibration	IEC68-2-64	
	Certification	CE, FCC Class A, RoHS	