

## CV-117/P2000

17" 6th Gen. Intel® Core™ Processor U Series Fanless  
Touch Panel PC with CFM & CDS Technology



- 17" SXGA TFT-LCD with Resistive 5-wire Touch, P-Cap Touch, or Glass Only
- Onboard Intel® 6th Generation Core™ Processor U Series (15W)
- 2x DDR4 SO-DIMM Socket, Support Up to 32 GB
- Integrated Intel® HD Graphics 520 Support Triple Display
- 2x 2.5" SATA HDD Bay, 1x mSATA and 1x CFAST Socket
- IP65 Compliant Aluminum Die-Cast Front Frame
- 2x Full-size Mini-PCIe Socket for Wireless and I/O Expansion
- Support CFM Technology for PoE and Ignition Sensing Functions
- Rich I/O (2x GbE LAN, 6x COM, 5x USB, 16x Isolated DIO)
- Support Instant Reboot Technology
- Wide Operating Temperature (-20°C to 70°C)
- SuperCap integrated for CMOS Battery Maintenance-Free
- PCI/PCIe Expandable Version Available (CV-117/P2002E)



### Overview

Cincoze CV-117/P2000 Series is a 17" high performance fanless and jumperless rugged touch panel PC powered by Intel® 6th generation Core™ processor U series, offering more computing power, faster data processing and a 40% boost to graphics performance, while consuming only 15W of power.

The CV-117/P2000 Series supports CFM (Control Function Module) Technology, Cincoze own defined interface with integrated power boost and control signal that allows you to extend PoE and ignition sensing functions with additional CFM boards. In addition Cincoze offers a full series of Mini-PCIe Expansion I/O Card (MEC) for adding extra I/O through the universal bracket. The CV-117/P2000 Series comes with the slim version, and the expandable version (PCI/PCIe card expansion) made with outstanding modular design concept for the greatest flexibility to fulfill the versatile industrial applications.

The CV-117/P2000 Series is a truly rugged computing system supporting wide operating temperature from -20°C to 70°C, wide range DC input from 9V to 48V, and various kinds of industrial protections. Moreover the instant reboot circuit design allows the system to cope with critical power request for factory applications. The CV-117/P2000 Series has an integrated SuperCap to avoid high downtime cost of replacing CMOS battery and be absolutely maintenance-free.

### Highlights

#### CDS Technology

CDS (Convertible Display Systems) is patented technology from Cincoze, which is a revolutionary panel PC solution that offers features of modular design, configured on demand, scalability, transformability and Plug & Play.

#### CFM Technology

CFM (Control Function Module) is a technology created by Cincoze, it enables function enhancement by adding specific CFM boards. CFM Technology allows CV-100/P2000 Series to support PoE and IGN function for various applications.

#### Instant Reboot

The CV-100/P2000 Series supports 0.2 second instant reboot for critical factory application.

#### SuperCap

SuperCap is an extremely high volume capacitor, which can be recharged automatically when power is connected (without power Min. 50 days / Max. 70 days), you never need to change CMOS battery, and it makes CV-100/P2000 Series a truly reliable and maintenance-free system.

## Specifications

### Display

- LCD Size: 17" (5:4)
- Max. Resolution: 1280 x 1024
- Brightness (cd/m2): 350
- Contrast Ratio: 800 : 1
- LCD Color: 16.7M
- Pixel Pitch (mm): 0.264 (H) x 0.264 (V)
- Viewing Angle (H-V): 160 / 140
- Backlight MTBF: 50,000 hrs (LED Backlight)

### Touch

- Resistive 5-wire Touch for CV-117R/P2000 Only
- Projected Capacitive Touch for CV-117C/P2000 Only

### Processor System

- Onboard 6th Intel® Core™ U processors (Skylake)
  - Intel® Core™ i5-6300U processor (3M Cache, up to 3.00 GHz)
  - Intel® Core™ i3-6100U processor (3M Cache, 2.30 GHz)
  - TDP: 15 W
  - BIOS: AMI 64Mbit SPI BIOS

### Memory

- 2x DDR4 260-pin SO-DIMM socket, support up to 32 GB (2133MHz, un-buffered and non-ECC type)

### Graphics

- Intel® HD Graphics 520
- Triple display with 1x VGA, 1x DVI-D and 1x CDS interface

### Audio

- Realtek® ALC888-GR
- High Definition Audio

### I/O Interface

- 1x VGA (Up to 1920 x 1080 @ 60Hz), DB-15
- 1x DVI-D (Up to 1920 x 1080 @ 60Hz)
- 1x CDS Interface, Compact PCI Connector
- 2x GbE LAN (Support WoL, Teaming, Jumbo Frame and PXE), RJ45
  - GbE1: Intel I219LM
  - GbE2: Intel I210
- 2x PoE+ (with Optional CFM PoE Module)
  - Comply with IEEE 802.3at, Offers Up to 25.5W Per Port
- 6x RS-232/422/485 with Auto Flow Control (Support 5V/12V), DB9
- 4x USB 3.0, Type-A
- 1x USB 2.0, Type-A
- 16x Isolated DIO (8x DI/8x DO), 20-Pin Terminal Block
- 1x Line-out & 1x Mic-in, Phone Jack 3.5mm
- 1x Power On/Off Switch
- 1x Reset Button
- 1x AT/ATX Switch
- 1x Remote Power On/Off Connector, 2-Pin Terminal Block
- 1x External FAN Connector, 4-Pin Terminal Block

### Storage

- 2x 2.5" SATA HDD/SSD Bay, Support RAID 0/1 (Gen3)
- 2x mSATA (One Shared by Mini-PCIe Socket) (Gen2)
- 1x CFast Socket (Gen3)

### Expansion

- 1x CFM PoE interface
- 1x CFM IGN interface
- 1x PCI or 1x PCIe4 Expansion slot [CV-117/P2002E]
  - Optional Riser Card: 1x PCI, 1x PCIe4
  - Support maximum dimension of add-on card (H x L): 100mm x 200mm
- 1x Universal I/O Bracket
- 1x SIM Socket
- 4x Antenna Hole

### Other Function

- Support CDS Technology
- Support CFM Technology
- Support Instant Reboot Technology (0.2 sec)
- Support Power Ignition Sensing (IGN)
- Support OSD Function (LCD On/Off, Brightness Up, Brightness Down for CDS Display Module)
- Internal Speaker AMP 2W + 2W
- SuperCap Integrated
- Watchdog Timer: Software Programmable Supports 256 Levels System Reset

### Power Requirement

- Support AT/ATX Power Mode
- Power Input Voltage 9~48VDC
- One 3-pin Terminal Block Connector
- Power Adapter AC/DC 12V/5A 60W, 24V/5A 120W or 24V/9.2A 220W (Optional)

### Physical

- Dimension (WxHxD): CV-117/P2002: 450 x 350 x 88.5 mm  
CV-117/P2002E: 450 x 350 x 106.5 mm
- Weight: CV-117/P2002: 8.56 kg  
CV-117/P2002E: 8.82 kg
- Die-cast Flat Surface
- Mounting: Panel / VESA / \*Rack Mounting (\*with optional mounting kit)
- Fanless Design
- Jumper-less Design

### Protection

- Reverse Power Input Protection
  - Protection Range: 51~58V
  - Protection Type: shut down operating voltage, re-power on at the preset level to recover
- Over Current Protection: 15A
- ESD Protection: +/-8kV (air), +/-4kV (contact)
- Surge Protection: 3kW

### Operating System

- Windows® 10
- Windows® 8.1
- Windows® 7
- Linux® Kernel 4.4

### Environment

- Operating Temperature:
  - CV-117R/P2002 & CV-117R/P2002E: -20°C to 70°C
  - CV-117R/P2002 & CV-117R/P2002E: -20°C to 70°C
  - CV-117G/P2002 & CV-117G/P2002E: -25°C to 70°C
 (With extended temperature peripherals; Ambient with air flow According to IEC60068-2-1, IEC60068-2-2, IEC60068-2-14)
- Storage Temperature:
  - CV-117R/P2002 & CV-117R/P2002E: -30°C to 80°C
  - CV-117C/P2002 & CV-117C/P2002E: -30°C to 80°C
  - CV-117G/P2002 & CV-117G/P2002E: -30°C to 85°C
- Relative Humidity:
  - CV-117R/P2002 & CV-117R/P2002E: 80% RH @ 40°C (Non-condensing)
  - CV-117C/P2002 & CV-117C/P2002E: 80% RH @ 40°C (Non-condensing)
  - CV-117G/P2002 & CV-117G/P2002E: 90% RH @ 40°C (Non-condensing)
- IP Level: IP65 Compliant Front Panel

**External Layout**

CV-117/P2002

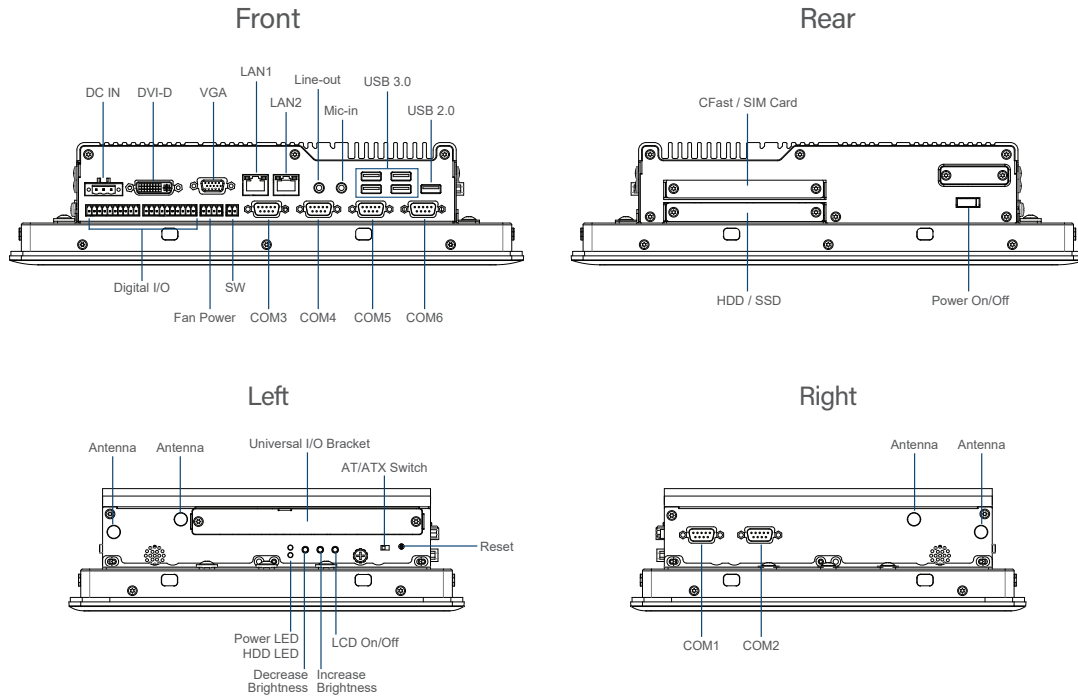

CV-117/P2002E

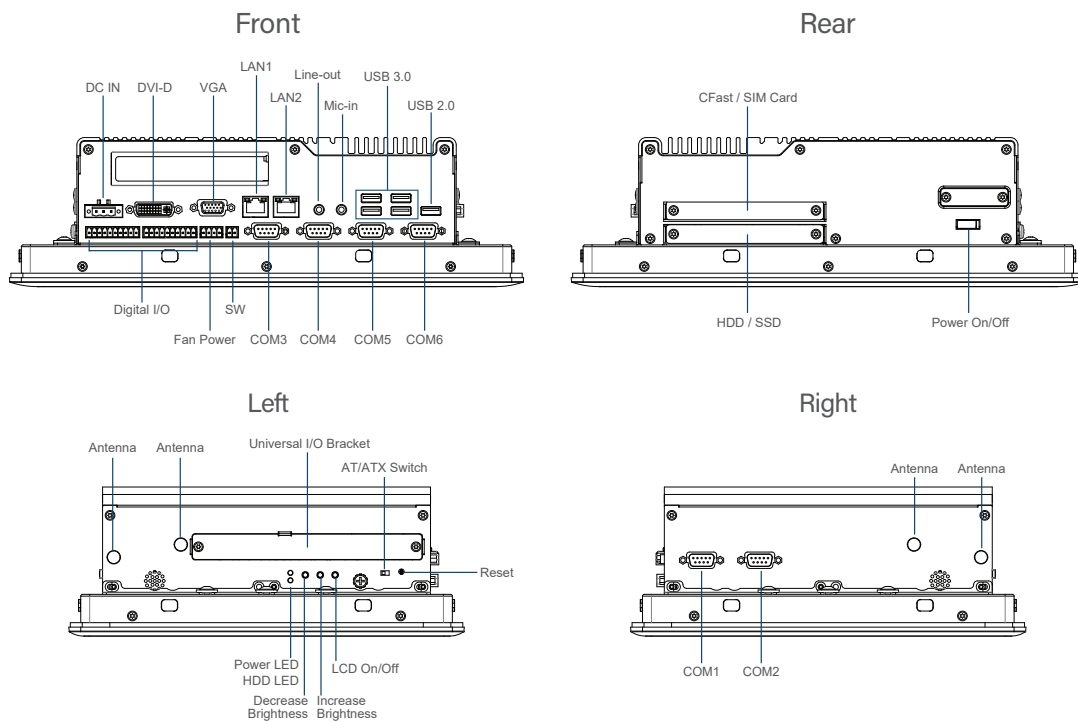

**Dimensions**

CV-117/P2002

Unit: mm

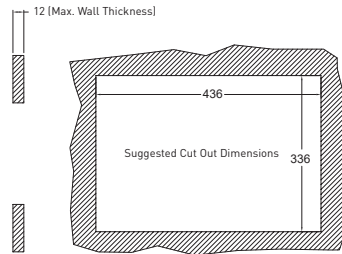
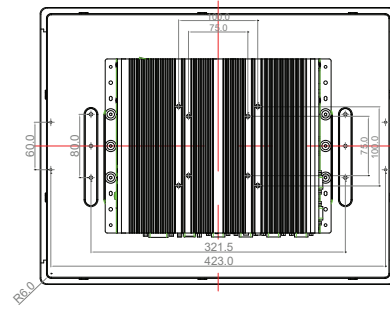
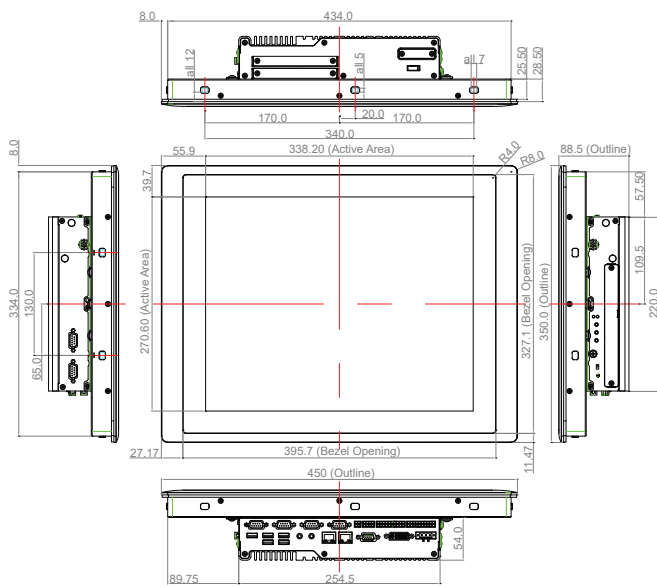

CV-117/P2002E

Unit: mm

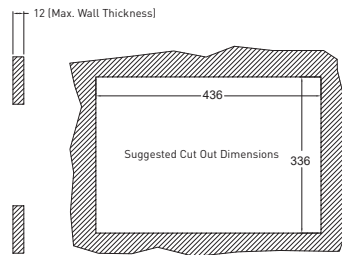
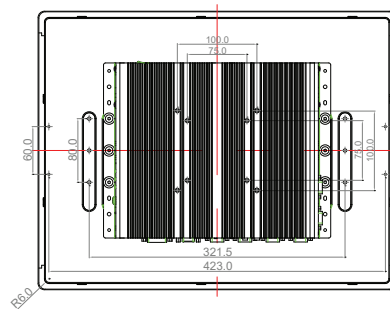
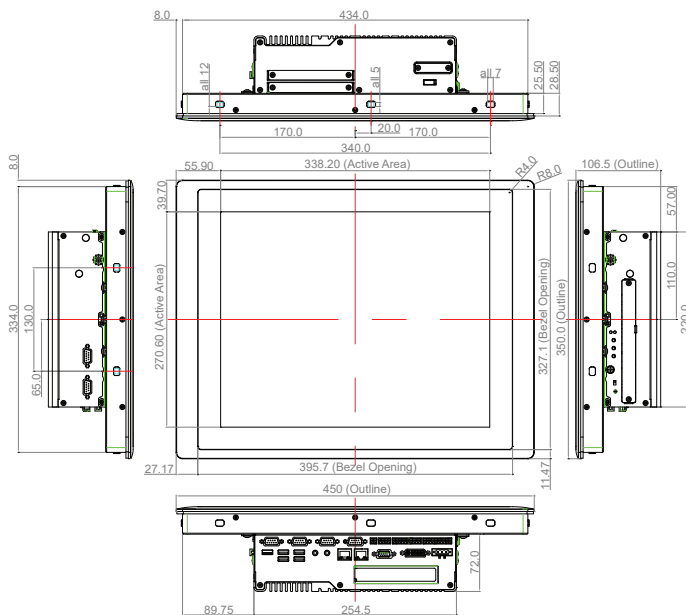

## Ordering Information

### Available Models

Model No.	Description
CV-117R-R10/P2002-i5-R10	17" TFT SXGA 5:4 Panel PC with Resistive 5-wire Touch and Intel 6th Gen. Core i5-6300U Fanless Computer,CFM Interface,CDS Interface
CV-117R-R10/P2002E-i5-R10	17" TFT SXGA 5:4 Panel PC with Resistive 5-wire Touch and Intel 6th Gen. Core i5-6300U Expandable Fanless Computer, CFM Interface, CDS Interface
CV-117R-R10/P2002E-i5-E4-R10	17" TFT SXGA 5:4 Panel PC with Resistive 5-wire Touch and Intel 6th Gen. Core i5-6300U Expandable Fanless Computer, CFM Interface, CDS Interface, 1x PCIe4 Expansion
CV-117R-R10/P2002E-i5-PI-R10	17" TFT SXGA 5:4 Panel PC with Resistive 5-wire Touch and Intel 6th Gen. Core i5-6300U Expandable Fanless Computer, CFM Interface, 1x PCI Expansion
CV-117C-R10/P2002-i5-R10	17" TFT SXGA 5:4 Panel PC with Projected Capacitive Touch and Intel 6th Gen. Core i5-6300U Fanless Computer, CFM Interface, CDS Interface
CV-117C-R10/P2002E-i5-R10	17" TFT SXGA 5:4 Panel PC with Projected Capacitive Touch and Intel 6th Gen. Core i5-6300U Expandable Fanless Computer, CFM Interface, CDS Interface
CV-117C-R10/P2002E-i5-E4-R10	17" TFT SXGA 5:4 Panel PC with Projected Capacitive Touch and Intel 6th Gen. Core i5-6300U Expandable Fanless Computer, CFM Interface, CDS Interface, 1x PCIe4 Expansion
CV-117C-R10/P2002E-i5-PI-R10	17" TFT SXGA 5:4 Panel PC with Projected Capacitive Touch and Intel 6th Gen. Core i5-6300U Expandable Fanless Computer, CFM Interface, CDS Interface, 1x PCI Expansion
CV-117G-R10/P2002-i5-R10	17" TFT SXGA 5:4 Panel PC without Touch and Intel 6th Gen. Core i5-6300U Fanless Computer, CFM Interface, CDS Interface
CV-117G-R10/P2002E-i5-R10	17" TFT SXGA 5:4 Panel PC without Touch and Intel 6th Gen. Core i5-6300U Expandable Fanless Computer, CFM Interface, CDS Interface
CV-117G-R10/P2002E-i5-E4-R10	17" TFT SXGA 5:4 Panel PC without Touch and Intel 6th Gen. Core i5-6300U Expandable Fanless Computer, CFM Interface, CDS Interface, 1x PCIe4 Expansion
CV-117G-R10/P2002E-i5-PI-R10	17" TFT SXGA 5:4 Panel PC without Touch and Intel 6th Gen. Core i5-6300U Expandable Fanless Computer, CFM Interface, CDS Interface, 1x PCI Expansion
CV-117R-R10/P2002-i3-R10	17" TFT SXGA 5:4 Panel PC with Resistive 5-wire Touch and Intel 6th Gen. Core i3-6100U Fanless Computer,CFM Interface,CDS Interface
CV-117R-R10/P2002E-i3-R10	17" TFT SXGA 5:4 Panel PC with Resistive 5-wire Touch and Intel 6th Gen. Core i3-6100U Expandable Fanless Computer, CFM Interface, CDS Interface
CV-117R-R10/P2002E-i3-E4-R10	17" TFT SXGA 5:4 Panel PC with Resistive 5-wire Touch and Intel 6th Gen. Core i3-6100U Expandable Fanless Computer, CFM Interface, CDS Interface, 1x PCIe4 Expansion
CV-117R-R10/P2002E-i3-PI-R10	17" TFT SXGA 5:4 Panel PC with Resistive 5-wire Touch and Intel 6th Gen. Core i3-6100U Expandable Fanless Computer, CFM Interface, 1x PCI Expansion
CV-117C-R10/P2002-i3-R10	17" TFT SXGA 5:4 Panel PC with Projected Capacitive Touch and Intel 6th Gen. Core i3-6100U Fanless Computer, CFM Interface, CDS Interface
CV-117C-R10/P2002E-i3-R10	17" TFT SXGA 5:4 Panel PC with Projected Capacitive Touch and Intel 6th Gen. Core i3-6100U Expandable Fanless Computer, CFM Interface, CDS Interface
CV-117C-R10/P2002E-i3-E4-R10	17" TFT SXGA 5:4 Panel PC with Projected Capacitive Touch and Intel 6th Gen. Core i3-6100U Expandable Fanless Computer, CFM Interface, CDS Interface, 1x PCIe4 Expansion
CV-117C-R10/P2002E-i3-PI-R10	17" TFT SXGA 5:4 Panel PC with Projected Capacitive Touch and Intel 6th Gen. Core i3-6100U Expandable Fanless Computer, CFM Interface, CDS Interface, 1x PCI Expansion
CV-117G-R10/P2002-i3-R10	17" TFT SXGA 5:4 Panel PC without Touch and Intel 6th Gen. Core i3-6100U Fanless Computer, CFM Interface, CDS Interface
CV-117G-R10/P2002E-i3-R10	17" TFT SXGA 5:4 Panel PC without Touch and Intel 6th Gen. Core i3-6100U Expandable Fanless Computer, CFM Interface, CDS Interface
CV-117G-R10/P2002E-i3-E4-R10	17" TFT SXGA 5:4 Panel PC without Touch and Intel 6th Gen. Core i3-6100U Expandable Fanless Computer, CFM Interface, CDS Interface, 1x PCIe4 Expansion
CV-117G-R10/P2002E-i3-PI-R10	17" TFT SXGA 5:4 Panel PC without Touch and Intel 6th Gen. Core i3-6100U Expandable Fanless Computer, CFM Interface, CDS Interface, 1x PCI Expansion

**Optional Modules**

Model No.	Description
CFM-IGN100	CFM Module with Power Ignition Sensing Control Function, 12V/24V Selectable (41 x 35 mm)
CFM-PoE100	PoE Control Function Module, Individual Port 25.5W (50 x 44 x 15 mm) (For CV-100/P2002 only)
CFM-PoE101	PoE Control Function Module, Individual Port 25.5W (50 x 44 x 33 mm) (For CV-100/P2002E only)
MEC-COM-M212/UB0503	Mini-PCIe Module with 2x COM Ports, 2x Universal Brackets (154 x 17 mm)
MEC-COM-M334/UB0504	Mini-PCIe Module with 4x RS-232/422/485 Serial Ports, 1x Universal Bracket (154 x 17 mm)
MEC-FIR-M003/UB0501	Mini-PCIe Module with 1x 1394A Port, 2x 1394B Ports, 1x Universal Bracket (154 x 17 mm)
MEC-LAN-M102-30/UB0511	Mini-PCIe Module with 2x LAN Ports, 2x 30cm cable / 1x Universal Bracket with 2x RJ45 Cutout for P2000 Series
MEC-USB-M002/UB0514	Mini-PCIe Module with 2x USB 3.0 Ports, 1x Universal Bracket (154 x 17 mm)
RC-E4-01	Riser Card with 1x PCIe4 Slot
RC-PI-01	Riser Card with 1x PCI Slot

**Optional Accessories**

Model No.	Description
GST60A12-CIN1	Adapter AC/DC 12V 5A 60W, GST60A12-CIN1, wide temp (-30°C ~ +70°C)
GST120A24-CIN	Adapter AC/DC 24V 5A 120W, GST120A24-CIN, wide temp (-30°C ~ +70°C), level VI
GST220A24-CIN	Adapter AC/DC 24V 9.2A 220W with 3pin Terminal Block Plug 5.0mm Pitch, with TUBES, GST220A24-CIN
SL2-SL3	US 2 heads power cord, US B type to IEC C13, SVT 18AWG/3C Black 1.8M
SL6-SL3	EU 2 heads power cord, EU G type to IEC C13, H05VV-F 0.75mm2/3G Black 1.8M
QP026-SL3	UK 2 heads power cord, UK I type to IEC C13, H05VV-F 0.75mm2/3G Black 1.8M
URM01	Universal 19" Rack Mount Kit for Industrial Panel PC & Industrial Monitor

**Package Checklist**

- Panel PC x 1
- Utility DVD Driver x 1
- Power Terminal Block Connector x 1
- Fan Terminal Block Connector x 1
- DIO Terminal Block Connector x 2
- Power On/Off Terminal Block Connector x 1
- Screw Pack x 1
- Panel Mounting Kit x 1

## Assured Systems

Assured Systems is a leading technology company with over 1,500 regular clients in 80 countries, deploying over 85,000 systems to a diverse customer base in 12 years of business. We offer high-quality and innovative rugged computing, display, networking and data collection solutions to the embedded, industrial, and digital-out-of-home market sectors.

### US

[sales@assured-systems.com](mailto:sales@assured-systems.com)

Sales: +1 347 719 4508  
Support: +1 347 719 4508

1309 Coffeen Ave  
Ste 1200  
Sheridan  
WY 82801  
USA

### EMEA

[sales@assured-systems.com](mailto:sales@assured-systems.com)

Sales: +44 (0)1785 879 050  
Support: +44 (0)1785 879 050

Unit A5 Douglas Park  
Stone Business Park  
Stone  
ST15 0YJ  
United Kingdom

VAT Number: 120 9546 28  
Business Registration Number: 07699660