

## CS-108/P1201 Series

8.4" TFT-LCD Sunlight Readable and Modular Panel PC with Intel® Elkhart Lake Atom® x6000E Series Processor



### POWER EFFICIENT SUNLIGHT READABLE PANEL PC

| CS-100/P1000 Series |

#### Overview

The CS-100/P1201 is a sunlight-readable panel PC with an Intel® Atom® (Elkhart Lake) processor and a maximum screen brightness of 1,600 nits. Available in a selection of screen sizes, aspect ratios, and brightnesses, the CS-100/P1201 has flexible expansion options, including rich native I/O interfaces (GbE LAN, USB 3.2, COM, and DIO), Mini PCIe and M.2 Key E Type 2230 expansion slots, and exclusive CFM expansion to add functions such as PoE and IGN. Cincoze's exclusive patented Convertible Display System (CDS) technology enables further flexible future computer performance upgrades and screen replacements. The robust CS-100/P1201 series is well-suited for outdoor kiosks or HMI applications.

- 8.4" TFT-LCD XGA with Ultra High Brightness up to 1,600 nits
- Intel® Elkhart Lake Atom® x6425E/x6211E Processor
- 1x DDR4 SO-DIMM
- Designed with Rugged Aluminum Die-casting Front Bezel
- Support Panel / VESA / Rack Mount
- Front Panel IP65 Compliant
- Wide Operating Temperature
- Cincoze Patent CDS Technology Support



### Next-gen Performance

The CS-100/P1201 supports up to an Intel® Atom® x6425E (Elkhart Lake) 4-core processor, with 1.7 times the single-thread performance, 1.5 times the multi-thread performance, and double the graphics performance of the previous-generation Apollo Lake processor. Up to 32 GB of 3200 MHz DDR4 is supported.

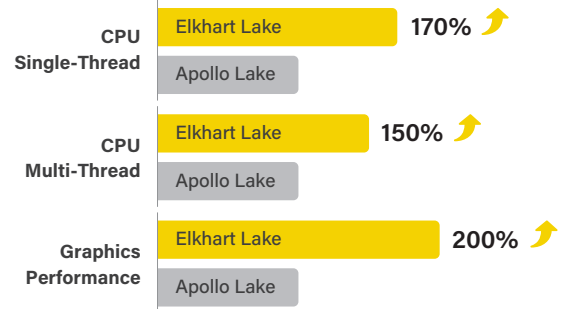

### Patented CDS Technology

Convertible Display System (CDS), the patented technology that connects the CS-100 display module to the P1201 embedded computer, has the advantages of easy maintenance in the field and easy future upgrades because the screen size can be changed and performance can be improved by only replacing a single part, rather than the whole system, saving on upgrade costs.

Patent No. M482908

### Comprehensive Range of Sizes

The CS-100/P1201 series has a diverse selection of screen sizes (8.4" to 24"), full HD resolution, a high brightness backlight of up to 1,600 nits, and a multi-point capacitive touchscreen to suit various application needs.

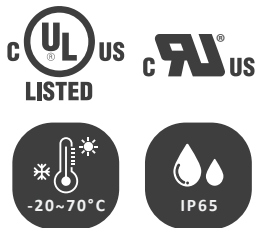

### Robust, Safe, Reliable

The CS-100/P1201 series has industrial-grade protections, including wide operating temperature (-20 to 70°C), wide-range DC power input (9 to 48 VDC), and IP65 front panel dust and water resistance, to face harsh outdoor environments and unpredictable climates such as on-site HMI and production process visualization. The CS-100/P1201 (19"-24" only) has separately passed product safety standards (UL certification) for information and communication technology and audio-visual equipment in the United States, an assurance of product safety.

**CS-108 Specifications**

Model Name	CS-108C
<b>Display</b>	
LCD Size	• 8.4" (4:3)
Max. Resolution	• 800 x 600
Brightness (cd/m2)	• 1600
Contrast Ratio	• 600 : 1
LCD Color	• 16.2M
Pixel Pitch (mm)	• 0.213 (H) x 0.213 (V)
Viewing Angle (H-V)	• 160 / 140
Backlight MTBF	• 50,000 hrs (LED Backlight)
<b>Touch Screen</b>	
Touch Type	• Projected Capacitive
<b>Physical</b>	
Dimension ( W x D x H )	• 262 x 186.2 x 56.2mm
Weight Information	• 1.58kg
Mechanical Construction	• Flat Rugged Aluminum Die-casting Bezel
<b>Environment</b>	
Front Panel Protection	• IP 65 Compliant
Operating Temperature	• Ambient with Air flow: -20°C to 70°C (extended temperature peripherals)
Storage Temperature	• -20°C to 70°C
Relative Humidity	• 85% RH @ 40°C (Non-condensing)
EMC	• CE, UKCA, FCC, ICES-003 Class A

## P1201 Specifications

Model Name	P1201
<b>System</b>	
Processor	<ul style="list-style-type: none"> <li>Intel® Atom® x6425E Processor (1.5M Cache, up to 3.00 GHz, 12W)</li> <li>Intel® Atom® x6211E Processor (1.5M Cache, up to 3.00 GHz, 6W)</li> </ul>
Memory	<ul style="list-style-type: none"> <li>1x DDR4 SO-DIMM Socket</li> <li>Supports DDR4 3200MHz Memory Up to 32GB (un-buffered and non-ECC)</li> </ul>
BIOS	<ul style="list-style-type: none"> <li>AMI BIOS</li> </ul>
<b>Graphics</b>	
Graphics Engine	<ul style="list-style-type: none"> <li>Integrated Intel® UHD Graphics</li> </ul>
Maximum Display Output	<ul style="list-style-type: none"> <li>Supports Triple Independent Display</li> </ul>
CDS	<ul style="list-style-type: none"> <li>1x CDS Connector (1920 x 1080 @60Hz)</li> </ul>
DP	<ul style="list-style-type: none"> <li>1x DisplayPort Connector (4096 x 2304 @ 60Hz, According to CPU Specifications)</li> <li>* Verified maximum resolution: 3840 x 2160 @60Hz</li> </ul>
VGA	<ul style="list-style-type: none"> <li>1x VGA Connector (1920 x 1200 @60Hz)</li> </ul>
<b>Audio</b>	
Audio Codec	<ul style="list-style-type: none"> <li>Realtek® ALC888, High Definition Audio</li> </ul>
Line-out	<ul style="list-style-type: none"> <li>1x Line-out, Phone Jack 3.5mm</li> </ul>
Mic-in	<ul style="list-style-type: none"> <li>1x Mic-in, Phone Jack 3.5mm</li> </ul>
<b>I/O</b>	
LAN	<ul style="list-style-type: none"> <li>2x 1GbE LAN, RJ45</li> <li>- GbE1: Intel® I210</li> <li>- GbE2: Intel® I210</li> </ul>
COM	<ul style="list-style-type: none"> <li>3x RS-232/422/485 with Auto Flow Control, DB9</li> </ul>
USB	<ul style="list-style-type: none"> <li>3x 10Gbps USB 3.2 Gen2, Type A</li> <li>1x 480Mbps USB 2.0, Type A</li> </ul>
DIO	<ul style="list-style-type: none"> <li>8x Isolated DIO (4x DI/4x DO), 10-Pin Terminal Block</li> </ul>
<b>Storage</b>	
SSD/HDD	<ul style="list-style-type: none"> <li>1x 2.5" Front Accessible SATA HDD/SSD Drive Bay ( SATA3.0 )</li> </ul>
mSATA	<ul style="list-style-type: none"> <li>1x mSATA Socket (SATA 3.0, shared by Mini-PCIe socket)</li> </ul>
<b>Expansion</b>	
Mini PCI Express	<ul style="list-style-type: none"> <li>1x Full-size Mini-PCIe Socket</li> </ul>
SIM Socket	<ul style="list-style-type: none"> <li>1x SIM Socket</li> </ul>
M.2	<ul style="list-style-type: none"> <li>1x M.2 Key E Type 2230 Socket, Support Intel® CNVi/Wireless Module</li> </ul>
CFM (Control Function Module) Interface	<ul style="list-style-type: none"> <li>1x CFM IGN Interface for optional CFM-IGN Module Expansion</li> <li>1x CFM PoE Interface for optional CFM-PoE Module Expansion</li> </ul>
CDS (Convertible Display System) Interface	<ul style="list-style-type: none"> <li>1x CDS Interface for Convertible Display Module</li> </ul>
<b>Other Function</b>	
Clear CMOS Switch	<ul style="list-style-type: none"> <li>1x Clear CMOS Switch</li> </ul>
Reset Button	<ul style="list-style-type: none"> <li>1x Reset Button</li> </ul>

Instant Reboot	• Support 0.2sec Instant Reboot Technology
Watchdog Timer	• Software Programmable Supports 256 Levels System Reset
OSD Button	• LCD On/Off, Brightness Up, Brightness Down
Internal Speaker	• AMP 2W + 2W
Status LED Indicator	• Power LED, HDD LED, Temperature LED
<b>Power</b>	
Power Button	• 1x ATX Power On/Off Button
Power Mode Switch	• 1x AT/ATX Mode Switch
Power Input	• 9 - 48VDC, 3-pin Terminal Block
Remote Power On/Off	• 1x Remote Power On/Off, 2-pin Terminal Block
Remote Power LED	• 1x Remote Power LED, 2-pin Terminal Block
<b>Operating System</b>	
Windows	• Windows® 10
Linux	• Supports by project
<b>Physical</b>	
Dimension ( W x D x H )	• 204.5 x 149 x 41.5 mm
Weight Information	• 1.54 kg
Mechanical Construction	• Extruded Aluminum with Heavy Duty Metal
Mounting	• Wall / VESA / CDS / DIN Rail
Physical Design	• Fanless Design • Jumper-less Design
<b>Reliability &amp; Protection</b>	
Reverse Power Input Protection	• Yes
Over Voltage Protection	• Protection Range: 51~58V • Protection Type: shut down operating voltage, re-power on at the preset level to recover
Over Current Protection	• 15A
CMOS Battery Backup	• SuperCap Integrated for CMOS Battery Maintenance-free Operation
MTBF	• 283,091 Hours - Database: Telcordia SR-332 Issue3, Method 1, Case 3
<b>Environment</b>	
Operating Temperature	• -40°C to 70°C * PassMark BurnInTest: 100% CPU, 2D/3D Graphics (without thermal throttling) * With extended temperature peripherals; Ambient with air flow * According to IEC60068-2-1, IEC60068-2-2, IEC60068-2-14
Storage Temperature	• -40°C to 85°C
Relative Humidity	• 95%RH @ 70°C (non-Condensing)
Shock	• Operating, 50 Grms (w/ SSD, according to IEC60068-2-27)
Vibration	• Operating, 5 Grms, 5-500 Hz, 3 Axes (w/ SSD, according to IEC60068-2-64) • Operating, 1 Grms, 10-500 Hz, 3 Axes (w/ SSD, according to IEC60068-2-6)
EMC	• CE, UKCA, FCC, ICES-003 Class A • EN61000-6-4, EN61000-6-2 (24VDC Input Only)
Safety	• UL, cUL, CB, IEC/EN 62368-1

**CS-108/P1201 External Layout**

Front I/O

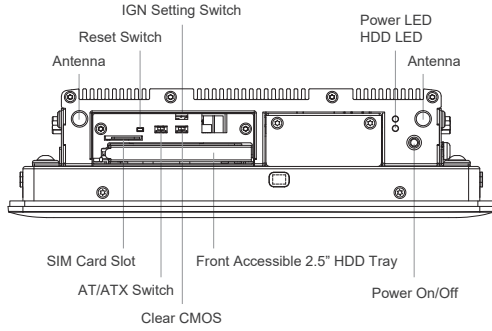

Rear I/O

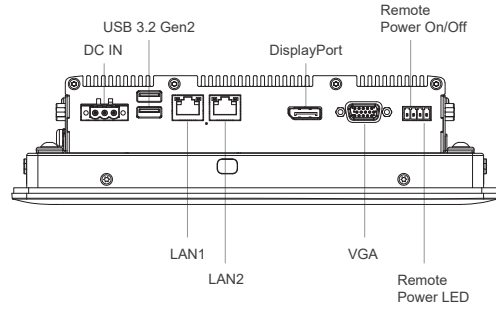

Left I/O

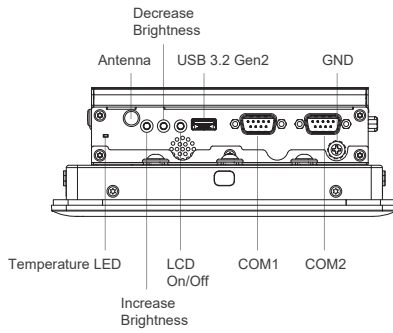

Right I/O

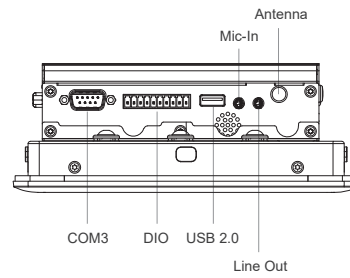

**CS-108/P1201 Dimensions**

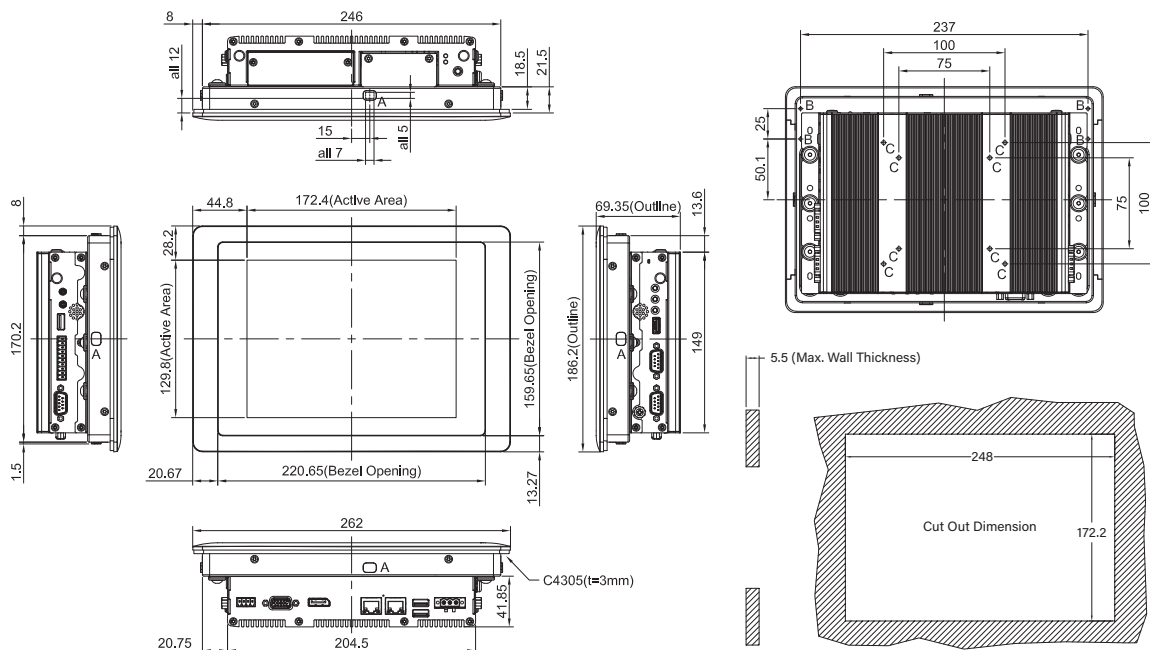

Unit: mm

## Ordering Information

### Available Models

Model No.	Description
CS-108C-R10/P1201-X6425E-R10	8.4" TFT-LCD 1600nits Sunlight Readable Touch Panel PC with Intel Atom x6425E Quad Core Processor
CS-108C-R10/P1201-X6211E-R10	8.4" TFT-LCD 1600nits Sunlight Readable Touch Panel PC with Intel Atom x6211E Dual Core Processor

### Model Configuration

	CS-108C	P1201-X6425E	P1201-X6211E
CS-108C/P1201-X6425E	V	V	--
CS-108C/P1201-X6211E	V	--	V

V : Compatible

### Package Checklist

• CS-108/P1201 Series Panel PC x 1	• Power Terminal Block Connector (Female) x 1
• Thermal Pad (for CPU Thermal Block) x 1	• Screw Pack x 1
• DIO Terminal Block Connector (Female) x 1	• Remote Power On/Off Terminal Block Connector x 1
• Panel Mounting Kit x 4	

### Optional Modules and Accessories

Model No.	Description
CFM-PoE02	CFM Module with PoE Control Function, Individual Port 25.5W
CFM-IGN101	CFM Module with Power Ignition Sensing Control Function, 12V/24V Selectable (43 x 36 mm)
URM01	Universal 19" Rack Mount Kit for Industrial Panel PC & Industrial Monitor
GST60A12-CIN1	Adapter AC/DC 12V 5A 60W, GST60A12-CIN1, wide temp(-30°C ~ +70°C)
GST120A24-CIN	Adapter AC/DC 24V 5A 120W, GST120A24-CIN, wide temp (-30°C ~ +70°C), level VI

Updated: Mar. 01, 2023

All product names, logos, and brands are the property of their respective owners. All company, product and service names used in this document are for identification purposes only. The use of these names, logos, and brands does not imply endorsement. © Cincoze Co., Ltd. All Rights Reserved. Specifications subject to change without notice.

## Assured Systems

Assured Systems is a leading technology company with over 1,500 regular clients in 80 countries, deploying over 85,000 systems to a diverse customer base in 12 years of business. We offer high-quality and innovative rugged computing, display, networking and data collection solutions to the embedded, industrial, and digital-out-of-home market sectors.

### US

[sales@assured-systems.com](mailto:sales@assured-systems.com)

Sales: +1 347 719 4508  
Support: +1 347 719 4508

1309 Coffeen Ave  
Ste 1200  
Sheridan  
WY 82801  
USA

### EMEA

[sales@assured-systems.com](mailto:sales@assured-systems.com)

Sales: +44 (0)1785 879 050  
Support: +44 (0)1785 879 050

Unit A5 Douglas Park  
Stone Business Park  
Stone  
ST15 0YJ  
United Kingdom

VAT Number: 120 9546 28  
Business Registration Number: 07699660