



50" Wall Mounted Android
Network Advertising Display

Overview

Integrated Android Media Player



The integrated Android Media Player allows for super fast updates. If required you can also run third party Digital Signage software via the Android PC board.

Commercial Grade

Designed for use in commercial applications this screen can run 24/7. No external buttons or controls to avoid tampering.

Built in Wi-Fi

Connect the screen to the CMS wirelessly via the integrated Wi-Fi, ethernet or by LAN

LED Backlight

Improves brightness and contrast as well as improving their lifespan and reducing their power consumption. Unlike other forms of light this technology is mercury free; making it even more eco-friendly. The panel and backlight have a lifespan in excess of 50,000 hours.

Attach Devices

If you want to use the screen as a monitor you can attach devices via HDMI and VGA.



Plug and Play

If there is no internet access available the screen can still be updated thanks to their backup USB update option. Simply package up your Playlist onto a USB stick and insert into the screen. Your templates, schedule and content will now copy over and start playing.

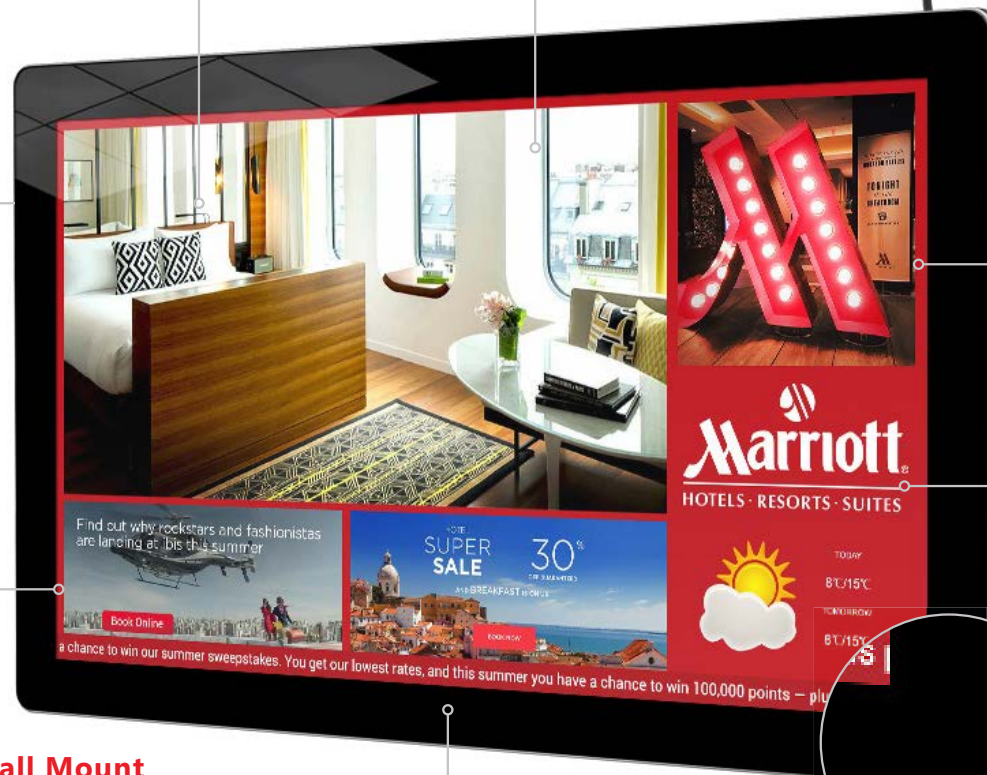

IPS Panel

Superior image quality and colour depth at 178° ultra wide viewing angle in both landscape and portrait orientations.

Giant Tablet Styling

Designed to resemble a giant smartphone or tablet. The sleek and sexy look is achieved with a striking aluminium surround and stunning IPX1 rated edge-to-edge glass.

Free Wall Mount

The screen comes with a super-slim wall mount that allows the screen to be securely mounted in either landscape or portrait orientation.

Portrait/Landscape Orientation

The screen can be used in either a landscape or portrait orientation depending on your requirement.

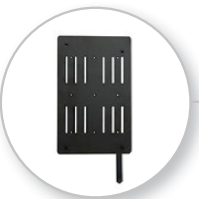



All-in-One Solution

Our screens have an integrated Android network media player; making installation a breeze. Typically network solutions require you to invest in additional networking hardware - complicating the installation process and the overall system. Hardware and software usually come from different sources which can result in confusion and conflict when identifying any potential faults. In contrast to this, any issues with our screens or Digital Signage software will be dealt with directly by us; one supplier, one solution.

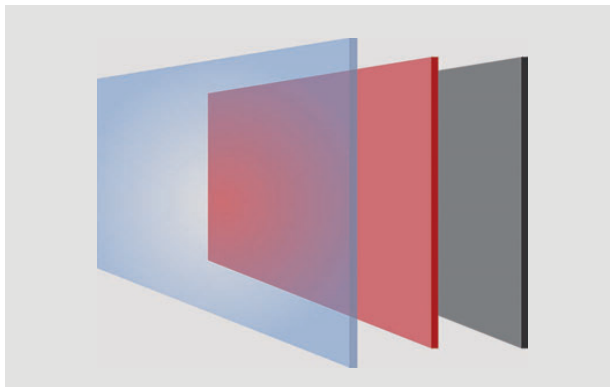

IPS Panel

Accurately displays an image's quality and colour depth at an 178° ultra wide viewing angle. There is no fall-off in colour accuracy and no diversion in contrast ratio at wide angles. From bright sunlight to the most challenging lighting environments these displays are designed to reproduce and maintain the ultimate colour temperature for lifelike images. The panel is also optimised for mounting in either landscape or portrait orientation.



24/7 Commercial Use

A commercial grade panel, with a lifespan of 50,000 hours, and high quality components ensure that this display can be in constant use 24/7. Tablet-like styling is achieved thanks to their tempered glass front and robust steel enclosure, framed in an unpainted aluminium surround, unlike cheap imitations



Easy Online Updates

Updating your screens is extremely simple. Login to [www. MySignagePortal.com](http://www.MySignagePortal.com) to upload media, manage playlists, create your own templates and schedule content for whenever you want; giving you complete control over your network. No special software installation or dedicated PC is required, you can update your screens from anywhere in the world with an internet connection.



Features

Connectivity



Connect your Android Network Screens to the internet wirelessly via Wi-Fi or via a Local Area Connection. If an internet connection is not available a 3G router can be incorporated into the screen, meaning that we can provide an integrated network solution for any location.

Create Custom Layouts

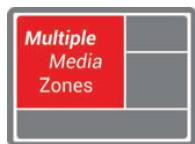

This feature allows you to design your own layout with different media zones for your images, videos, webpages, time, date and also allows you to add a scrolling message or RSS feed. You can even give your layout a corporate "skin" to go around your media zones.

Schedule Playlists



Display what you like, when you like. Create playlists that will automatically display your desired content a pre-determined times and dates. Whatever your scheduling requirements, our system can support them.

Android Media Player



Their integrated Android network media player provides super-fast processing speed for improved communication with the CMS. It also allows you to display live websites; this can be anything from a live web feed from a third party to your social media page. Should you need to you can also run your own software if you already have a CMS solution.

Update From Anywhere



Content can be uploaded and managed from anywhere in the world via our web portal, simply login, upload your images and videos to our secure server and send them directly to your screens.

Ultimate Remote Controls



Thanks to the all-in-one nature of the screens you can remotely control functions such as adjusting your screen's brightness, rebooting or formatting your screen, playing and stopping content, adjusting the volume and scheduling on/off times; a truly centralised solution.

Multi Screen Synchronisation

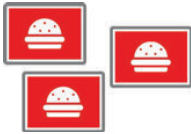

You can synchronise the content across multiple screens that are connected to the same network. This is ideal for advertising networks on escalators or along lengthy corridors.

Live Webpages



Display live webpages as part of your layout. You can use third party software, such as the kind that Estate Agents use, to generate a live web feed for your screen. The display will then automatically update as the page does. Social Media feeds, such as Facebook and Twitter feeds, can also be displayed here alongside your other media zones.

RSS Feeds



Display your RSS feed in the form of a scrolling text message. This can be anything from up-to-date news and weather to the latest movie reviews and currency exchange rates.

Manage Users



Create as many bespoke user accounts as you like. You may wish to limit some functions of the software to specific users, for example you may wish to allow a receptionist to upload media and have access to the screen in the reception area but nothing else - our system allows full user rights control.

Custom Background/Font Colors

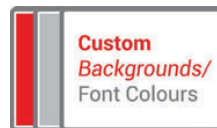

Customise your colours - great for maintaining brand consistency. You can choose a colour from the palette or enter a Hex code to modify the colour of your background, scrolling text, static text, time and date.

Office Documents & PDF's



Display Microsoft Office Documents and PDF's on your Network Screen. Simply upload Word, Excel, PowerPoint and PDF files to the CMS and now you can insert these files into zones alongside regular images and videos.



Network Features

Static Text

Allows you to input custom text values

Office Documents & PDF's

Display PDF files alongside Microsoft Word, Excel and PowerPoint files

Webpages

Allows you to display a live webpage such as a social media page or live web feed

Videos

Multiple videos playing in a continuous rolling loop

Image

Multiple images playing in a continuous rolling loop

Logo

Brand your layout with your logo which will stay on top of all other zones

Scrolling Text

Display a ticker tape message or live RSS feed. From here you can adjust the font, size, colour, speed and direction of the text

Time

Display the time in a variety of formats, sizes and in whatever colour you want

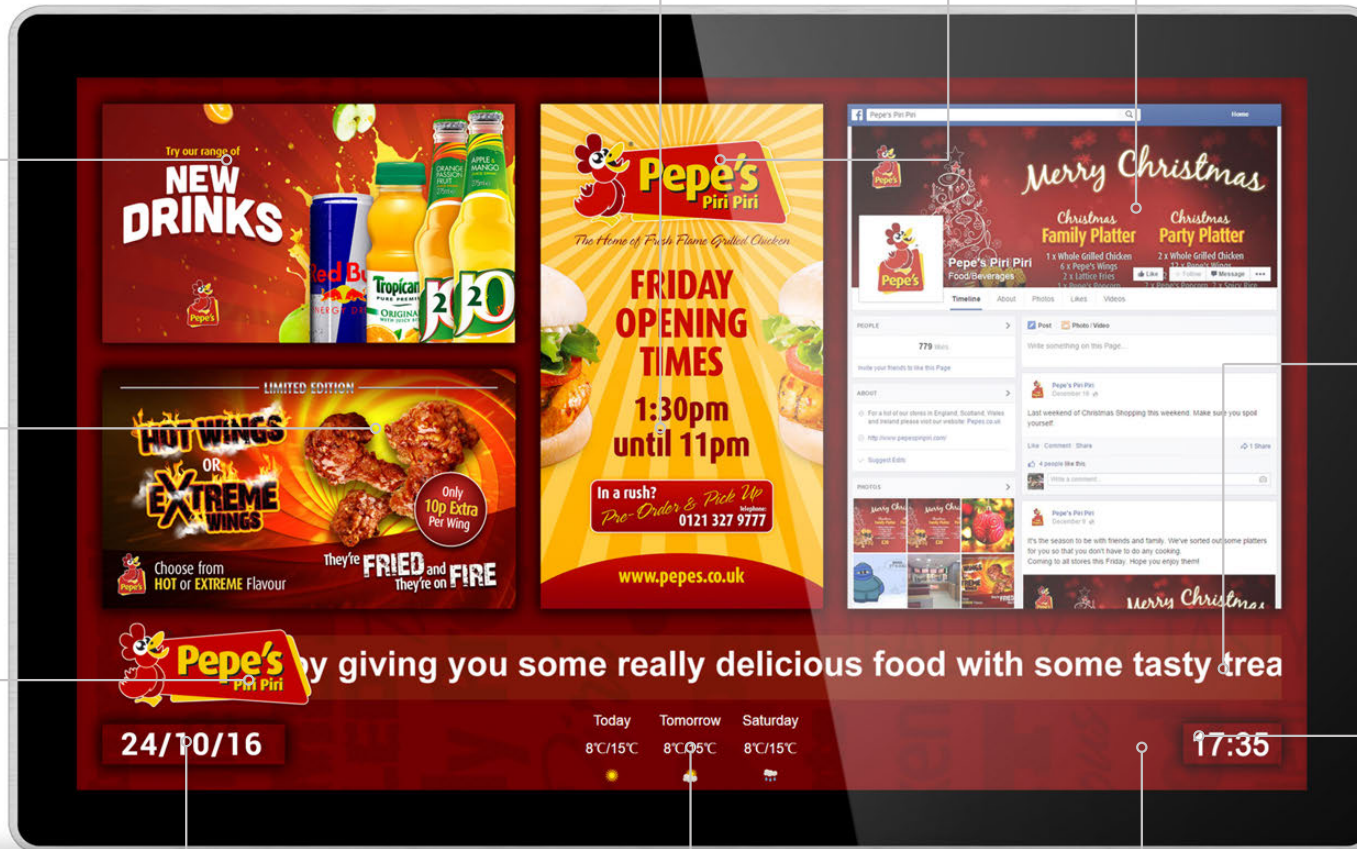

Date

Display the date in a variety of formats, sizes and in whatever colour you want

Weather Widget

Display a real time weather forecast for up to the next three days

Background

Set an image or a colour to frame your media zones

Panel	Display Size		50 Inch
	Resolution	1920x1080	
	Display Area (mm)	1075.6x605.4	
	Aspect Ratio	16:9	
	Brightness (cd/m2)	450	
	Colour	16.7M	
	Viewing Angle	178°	
	Contrast Ratio	5000:1	
Audio	Speaker Type	5W, 8Ω (x2)	
AV Inputs	Video	HDMI, VGA	
	Audio	Audio Socket (3.5mm)	
Power	Power Consumption (W)	75	
	Input Voltage	AC110~240V (50Hz~60Hz)	
Mechanical	Unit Size (WxHxD mm)	1199x736x44	
	Package Size (WxHxD mm)	1357x867x176	
	VESA Holes (mm)	400x400	
	Net Weight (kg)	28.05	
	Gross Weight (kg)	37	
Environmental	Operating Temperature	0°C to 50°C	
	Storage Temperature	-30°C to 60°C	
	Operating Humidity	10% to 80%	
	Storage Humidity	5% to 95%	
Computer	Internal Media Player	Media Formats	Video (MPG, AVI, MP4, RM, RMVB, TS), Audio (MP3, WMA), Image (JPG, GIF, BMP, PNG)
		Media Resolution	1920x1080/1080x1920
		Internal Memory	6GB
		CPU	Dual-Core Cortex-A9 @1.6GHz
		GPU	Mali-400 MP4 @400MHz
		RAM	1GB DDR3
		ROM	8GB NAND
		USB	USB2.0 HOST (x2)
		LAN	10/100M Ethernet (Network version screen only)
		Wi-Fi	802.11b/g/n (Network version screen only)
		OS	Android 4.2.2
Graphic Engine	OpenGL ES 1.1/2.0, OpenVG 1.1		
Special	Multiple Zones, Background Image, Scrolling Text Message, Static Text, Editable Background Colours, Editable Font Colours, Time and Date, Remote Commands, User Management, Multi-screen Synchronisation		
Accessories	Included	Wall Mount, Scheduling Software, Remote Control, Key, User Manual	
	Optional	Network Upgrade, Touch Screen Upgrade, Special Wall Mount, Floor Stand/Trolley, Ceiling Mount, Table Stand	

Technical Drawing:

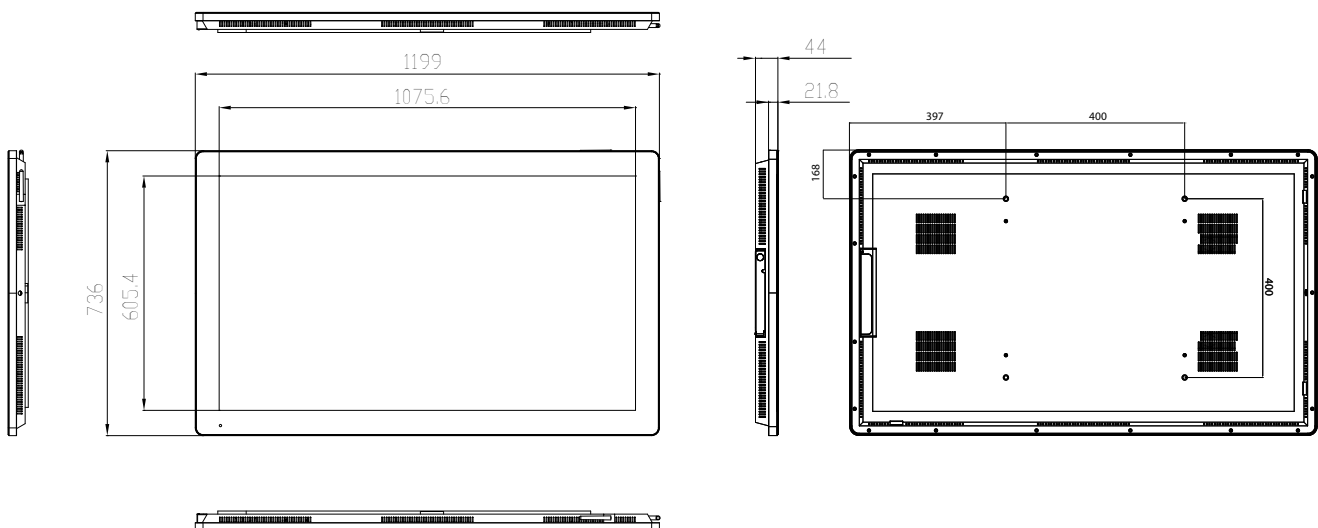

Errors and omissions excepted

Assured Systems

Assured Systems is a leading technology company with over 1,500 regular clients in 80 countries, deploying over 85,000 systems to a diverse customer base in 12 years of business. We offer high-quality and innovative rugged computing, display, networking and data collection solutions to the embedded, industrial, and digital-out-of-home market sectors.

US

sales@assured-systems.com

Sales: +1 347 719 4508
Support: +1 347 719 4508

1309 Coffeen Ave
Ste 1200
Sheridan
WY 82801
USA

EMEA

sales@assured-systems.com

Sales: +44 (0)1785 879 050
Support: +44 (0)1785 879 050

Unit A5 Douglas Park
Stone Business Park
Stone
ST15 0YJ
United Kingdom

VAT Number: 120 9546 28
Business Registration Number: 07699660