

15" POS Android Advertising Displays

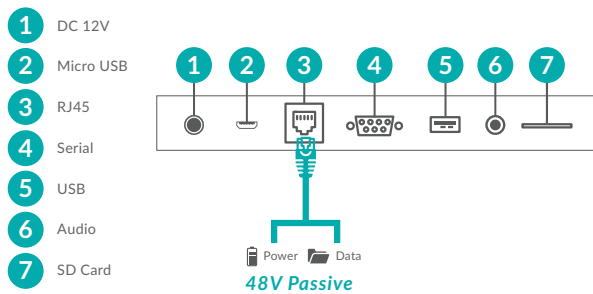

Power Over Ethernet (PoE)









Power your screen by using the power cable provided or supply the power over an Ethernet cable. This minimises the number of cables needed for installation as you can supply power and internet connectivity to the screen simultaneously.



Stylish Enclosure

The modern enclosure is crafted from moulded polymer for ultimate aesthetics. With its pure black finish and rounded corners the screen can fit seamlessly in many environments such as corporate offices or retail spaces.



-  Android Media Player
-  Headphone Output
-  No Integrated Battery
-  Integrated VESA Mounting Holes
-  Free Security Wall Mount
-  Power Timer
-  Extend Memory with SD Card
-  White Version Available

Other Features

Plug and Play

Plug and Play is the most straightforward way to upload content to the screen. Simply load images and videos onto a USB stick, insert into the display, wait for your content to copy over and then remove. Your images and videos will now play in a continuous loop.



24/7 Commercial Use

These displays use a commercial grade LCD panel and LED backlight. They have the ability to be in constant use 24/7 for over 70,000 hours and have no external buttons or controls to avoid tampering.



No Integrated Battery

Unlike domestic tablets these displays do not have built-in batteries and therefore last considerably longer. They are designed to be used constantly 24/7 in public spaces and can be powered directly from the mains or over PoE.



VESA Mounting Holes

Unlike domestic tablets these displays have an integrated and secure screw based mounting solution on the rear for easy wall or stand installation.

100 x100
VESA



Integrated Camera

If the software you are using requires a camera you can use the screen's integrated front facing 2 megapixel camera.

2 Megapixel Camera



Multi Coloured LED Frame

The LED edges either side of the display can be red, green or blue. They can also be disabled completely if preferred.



Available in 3 Colours

Power Timer

The eco-friendly power timer allows you to assign daily or weekly on and off times for your screen meaning that it is only in use when it needs to be; improving your environmental efficiency.



Optional NFC Integration

For projects that require Near Field Communication an internal module can be implemented for even more interactivity and engagement.



Key Features



PLUG AND PLAY



INTEGRATED CAMERA



LANDSCAPE OR PORTRAIT ORIENTATION



24/7 COMMERCIAL GRADE



INTEGRATED SPEAKERS



ANDROID MEDIA PLAYER



HEADPHONE OUTPUT



MULTI-COLOUR LED FRAME

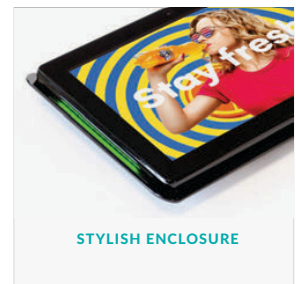
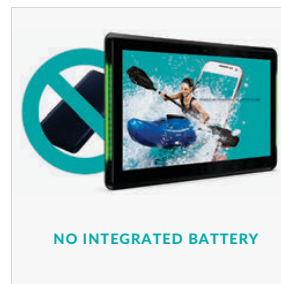
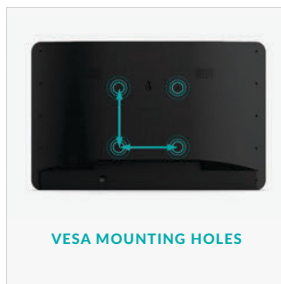
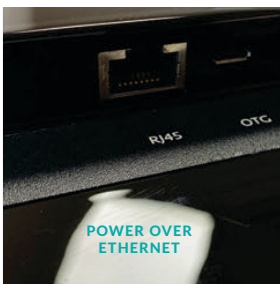

Specification Table

		15 Inch
Panel	Resolution	1920x1080
	Display Area (mm)	345x194
	Aspect Ratio	16:9
	Brightness (cd/m ²)	450
	Colour	16.7M
	Colour Depth	10 Bit
	Viewing Angle	178°
	Contrast Ratio	800:1
Audio	Speaker Type	2x1.5W
AV Inputs	Video	Micro USB, 1x USB 3.0, 1x USB 2.0
	Audio	Audio Socket (3.5mm)
Power	Power Consumption (W)	13.5
	Input Voltage	12V/2A
	PoE Mode	48V Passive
Mechanical	Unit Size (WxHxD mm)	401.8x252.9x30.2
	Package Size (WxHxD mm)	493x303x70
	VESA Holes (mm)	100x100
	Net Weight (kg)	1.4
	Gross Weight (kg)	2.25
Environmental	Operating Temperature	0 °C to 50 °C
	Storage Temperature	-30°C to 60°C
	Operating Humidity	10% to 80%
	Storage Humidity	5% to 95%
Computer	Media Formats	Video (MPG, AVI, MP4, RM, RMVB, TS), Audio (MP3, WMA), Image (JPG, GIF, BMP, PNG)
	Media Resolution	1920x1080/1080x1920
	CPU	Quad-core Cortex-A17 1.8GHz,RockChip RK3288
	GPU	Mali-T764
	RAM	2GB
	ROM	8GB
	Storage Extension	SD Card
	USB	USB3.0 HOST x1
	Wi-Fi	802.11b/g/n
	LAN	100M/1000M
	Bluetooth	Bluetooth 4.0
	OS	Android 8.1
	Graphic Engine	OpenGL ES 1.1/2.0
Accessories	Included	Wall Mount
	Optional	Network Upgrade, PCAP Touch Screen Upgrade, Table Stand, Near Field Communication
Warranty	Warranty Period	3 Year Warranty
	Technical Support	Lifetime

Errors and omissions excepted



Technical Drawing

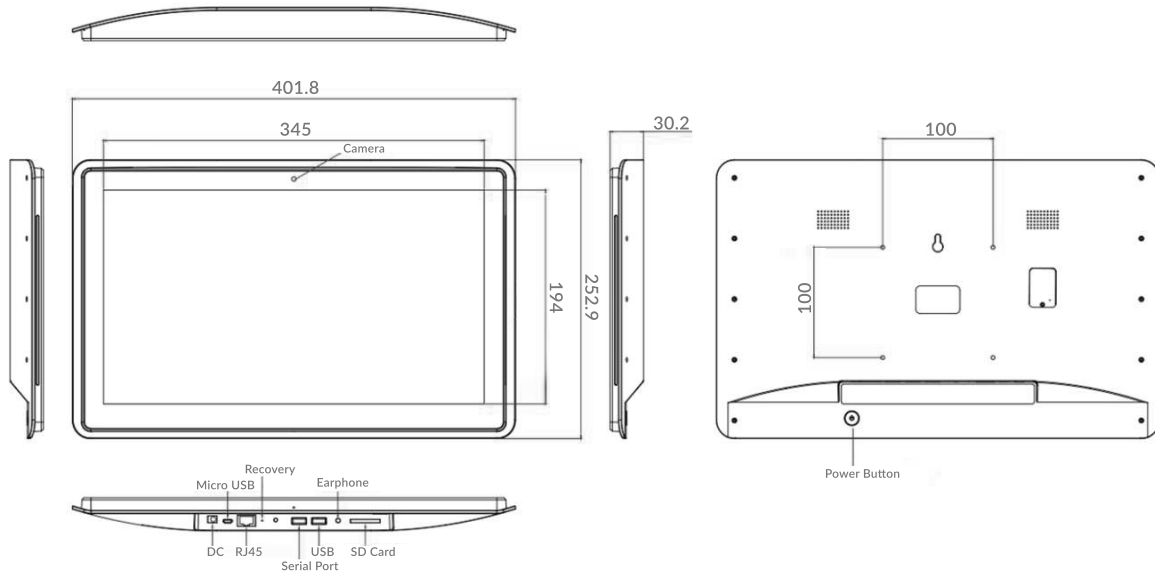

Assured Systems

Assured Systems is a leading technology company with over 1,500 regular clients in 80 countries, deploying over 85,000 systems to a diverse customer base in 12 years of business. We offer high-quality and innovative rugged computing, display, networking and data collection solutions to the embedded, industrial, and digital-out-of-home market sectors.

US

sales@assured-systems.com

Sales: +1 347 719 4508

Support: +1 347 719 4508

1309 Coffeen Ave
Ste 1200
Sheridan
WY 82801
USA

EMEA

sales@assured-systems.com

Sales: +44 (0)1785 879 050

Support: +44 (0)1785 879 050

Unit A5 Douglas Park
Stone Business Park
Stone
ST15 0YJ
United Kingdom

VAT Number: 120 9546 28

Business Registration Number: 07699660