

EC500-ADS

H610E
Q670E
R680E



12th Gen Intel® Core™
Modular-Designed Embedded System



KEY FEATURES



DDR4

DDR4 SODIMM up to 64GB



Wide-Temperature

Operating temperature: -20 to 70°C



Three Independent Displays

1 VGA + 2 HDMI/DP++ (auto detection)



Multiple Expansion

3 M.2 slots (1 M.2 2230 E key, 1 M.2 3042/3052 B key, 1 M.2 2280 M key)



Rich I/O

2 GbE, 6 COM, 4 USB 3.1, 2 USB 2.0



Support 5G Communication

Support 5G communication



PANEL

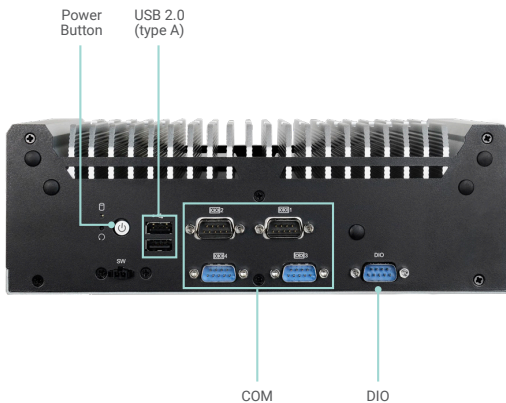

Front View

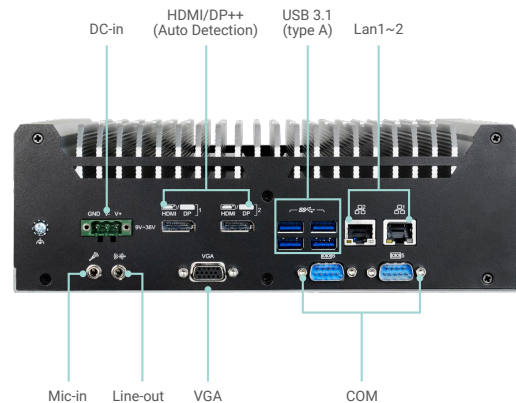

Rear View

DIMENSIONS

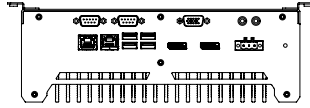

Rear View

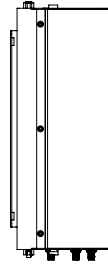

Left View

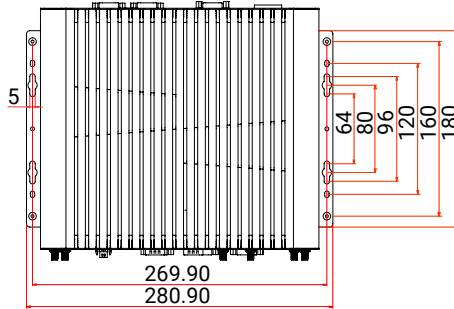

Top View

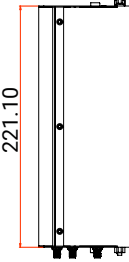

Right View

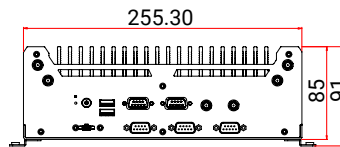

Front View

WALL MOUNTING

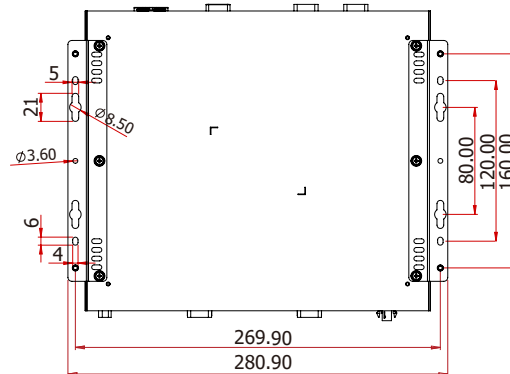
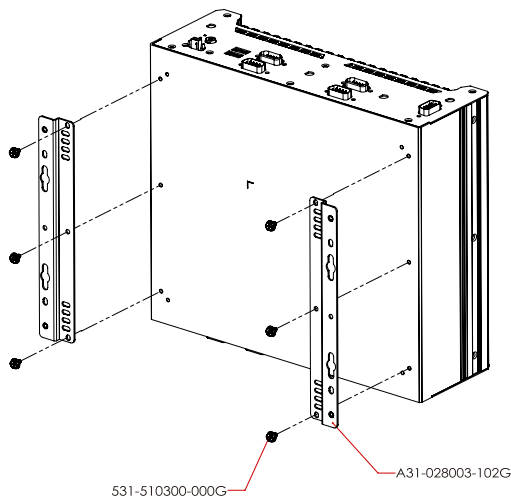

SPECIFICATION

SYSTEM	Processor	12th Generation Intel® Core™ Processors, LGA 1700 Intel® Core™ i9-12900TE (16 Cores, 30M Cache, up to 4.8GHz); 35W Intel® Core™ i7-12700TE (12 Cores, 25M Cache, up to 4.6GHz); 35W Intel® Core™ i5-12500TE (6 Cores, 18M Cache, up to 4.3GHz); 35W Intel® Core™ i3-12100TE (4 Cores, 12M Cache, to 4GHz); 35W Intel® Pentium® G7400TE (2 Cores, 6M Cache, 3GHz); 35W Intel® Celeron® G6900TE (2 Cores, 4M Cache, 2.4GHz); 35W	
	Chipset	Intel® H610E/Q670E/R680E Chipset	
	Memory	Two 260-pin DDR4 3200MHz SODIMM up to 64GB	
	BIOS	AMI SPI 128Mbit	
	GRAPHICS	Controller	Intel® HD Graphics
Feature		OpenGL up to 5.0, DirectX 11, OpenCL 2.1 HW Decode: HEVC/H.265, H.264, M/JPEG, MPEG2, VC1/WMV9, VP8 (8-bit), VP9 (10-bit) HW Encode: HEVC/H.265, M/JPEG, MPEG2, VP8	
Display		1 x VGA 2 x HDMI/DP++ (auto detection)	VGA: resolution up to 1920x1200 @ 60Hz HDMI: resolution up to 4096x2160 @ 30Hz DP++: resolution up to 4096x2304 @ 60Hz
STORAGE	Internal	2 x 2.5" SATA 3.0 Drive Bay support RAID 0/1 (Q670E/R680E)	
EXPANSION	Interface	Q670E/R680E: 1 x M.2 2230 E key (PCIe/USB 2.0) 1 x M.2 2280 M key (PCIe x4 NVMe/SATA) 1 x M.2 3042/3052 B key (PCIe/USB3.0) H610E: 1 x M.2 2230 E key (PCIe/USB 2.0) 1 x M.2 3042/3052 B key (PCIe)	
		Audio Codec	Realtek ALC888
ETHERNET	Controller	2 x Intel® I225IT PCIe (10/100/1000Mbps)	
LED	Indicators	1 x Status LED 1 x HDD LED	
FRONT I/O	Serial	4 x RS-232/422/485 (DB-9)	
	USB	2 x USB 2.0 (type A)	
	DIO	8 bit (DB-9)	
	Buttons	1 x Power button 1 x Reset button	
	Antenna	4 x Antenna hole	
REAR I/O	Ethernet	2 x GbE (RJ-45)	
	Serial	2 x RS-232 (DB-9)	
	USB	4 x USB 3.1 (type A)	
	Display	VGA + 2 x HDMI/DP++ (auto detection)	
	Audio	1 x Line-out 1 x Mic-in	
WATCHDOG TIMER	Output & Interval	System reset, programmable via software from 1 to 255 seconds	
SECURITY	TPM	TPM 2.0	
POWER	Type	Wide range 9~36V	
	Connector	3-pole terminal nlock 3-pin power extension switch connector	
OS SUPPORT	Window	Windows 10 IoT Enterprise 2021 LTSC	
	Linux	Linux (available upon request)	
MECHANISM	Construction	Metal + Aluminum	
	Mounting	Wall Mount	
	Dimensions (W x H x D)	255.3 x 85 x 224mm	
	Weight	4.15 kg	
ENVIRONMENT	Operating Temperature	-20 to 70°C (SSD or M.2 storage)	
	Storage Temperature	-20 to 85°C	
	Relative Humidity	5 to 95% RH (non-condensing)	
STANDARDS AND CERTIFICATIONS	Shock	Half sine wave 3G, 11ms, 3 shock per axis	
	Vibration	IEC68-2-64	
	Certification	CE, FCC Class A, RoHS, UKCA, BIS	

ORDERING INFORMATION

Model Name	Part Number	Description
EC500-ADS6861-H	750-EC5005-000G	EC500-ADS6861-H, Fanless, ADS263, H610E, i5-12500TE, 6 COM, 8 DIO, 6 USB, 1 VGA, 2 HDMI/DP, 2 LAN, 1 Line-out, 1 Mic-in, DC9~36V, TPM2.0, F/G SYSTEM RoHS
EC500-ADS6861-Q	750-EC5005-100G	EC500-ADS6861-Q, Fanless, ADS263, Q670E, i5-12500TE, 6 COM, 8 DIO, 6 USB, 1 VGA, 2 HDMI/DP, 2 LAN, 1 Line-out, 1 Mic-in, DC9~36V, TPM2.0, F/G SYSTEM RoHS
EC500-ADS6861-R	750-EC5005-200G	EC500-ADS6861-R, Fanless, ADS263, R680E, i5-12500TE, 6 COM, 8 DIO, 6 USB, 1 VGA, 2 HDMI/DP, 2 LAN, 1 Line-out, 1 Mic-in, DC9~36V, TPM2.0, F/G SYSTEM RoHS

PACKING LIST

1 EC500-ADS system unit
1 M.2 slot screws
1 Terminal block 3 pole for DC input
1 Cable with 2 wire stripped and tinned to DC jack

Assured Systems

Assured Systems is a leading technology company with over 1,500 regular clients in 80 countries, deploying over 85,000 systems to a diverse customer base in 12 years of business. We offer high-quality and innovative rugged computing, display, networking and data collection solutions to the embedded, industrial, and digital-out-of-home market sectors.

US

sales@assured-systems.com

Sales: +1 347 719 4508
Support: +1 347 719 4508

1309 Coffeen Ave
Ste 1200
Sheridan
WY 82801
USA

EMEA

sales@assured-systems.com

Sales: +44 (0)1785 879 050
Support: +44 (0)1785 879 050

Unit A5 Douglas Park
Stone Business Park
Stone
ST15 0YJ
United Kingdom

VAT Number: 120 9546 28
Business Registration Number: 07699660